

СОСТАВ ДЕТАЛЕЙ:



1 Мотор



2 Переходник-крепеж



3 Пластина 45x25



4 Пластина 45x45



5 Пластина 55x45



6 Пластина 65x25



7 Пластина 65x45



8 Пластина 65x65



9 Пластина 75x25



10 Пластина 75x45



11 Пластина 95x25



12 Пластина 95x45



13 Пластина 105x25



14 Пластина 125x25



15 Кронштейн большой



16 Кронштейн маленький



17 Пластина 105x25

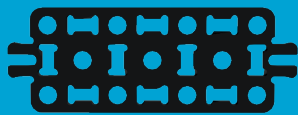

18 Пластина 125x45



19 Пластина угловая без шипов



20 Пластина угловая с шипами



21 Пластина угловая с шипом



22 Пластина 245x45



23 Пластина 225x45



24 Пластина 245x25



26 Обод большого колеса



27 Обод маленького колеса



28 Покрышка большая



29 Покрышка маленькая



30 Рукоятка



25 Пластина 225x25

31 Подшипник



32 Шарик



33 Шестеренка 15 зубцов



34 Шестеренка 45 зубцов



35 Шестеренка 75 зубцов



36 Шайба 10мм на ось



37 Шайба 22мм на ось



38 Шайба 45мм



39 Шайба M3



40 Шайба на винт



41 Винт 8 мм



42 Винт 25 мм



43 Втулка 5 мм



44 Втулка 5 мм



45 Втулка 10 мм



46 Ось 25 мм



47 Ось 45 мм



48 PCHSS-5



49 Втулка 15 мм

СОДЕРЖАНИЕ



ИСПОЛЬЗУЕМЫЕ ДЕТАЛИ ДЛЯ СБОРКИ

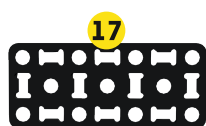

2шт



1шт



2шт



8шт



1шт



1шт



2шт



5шт



1шт



3шт

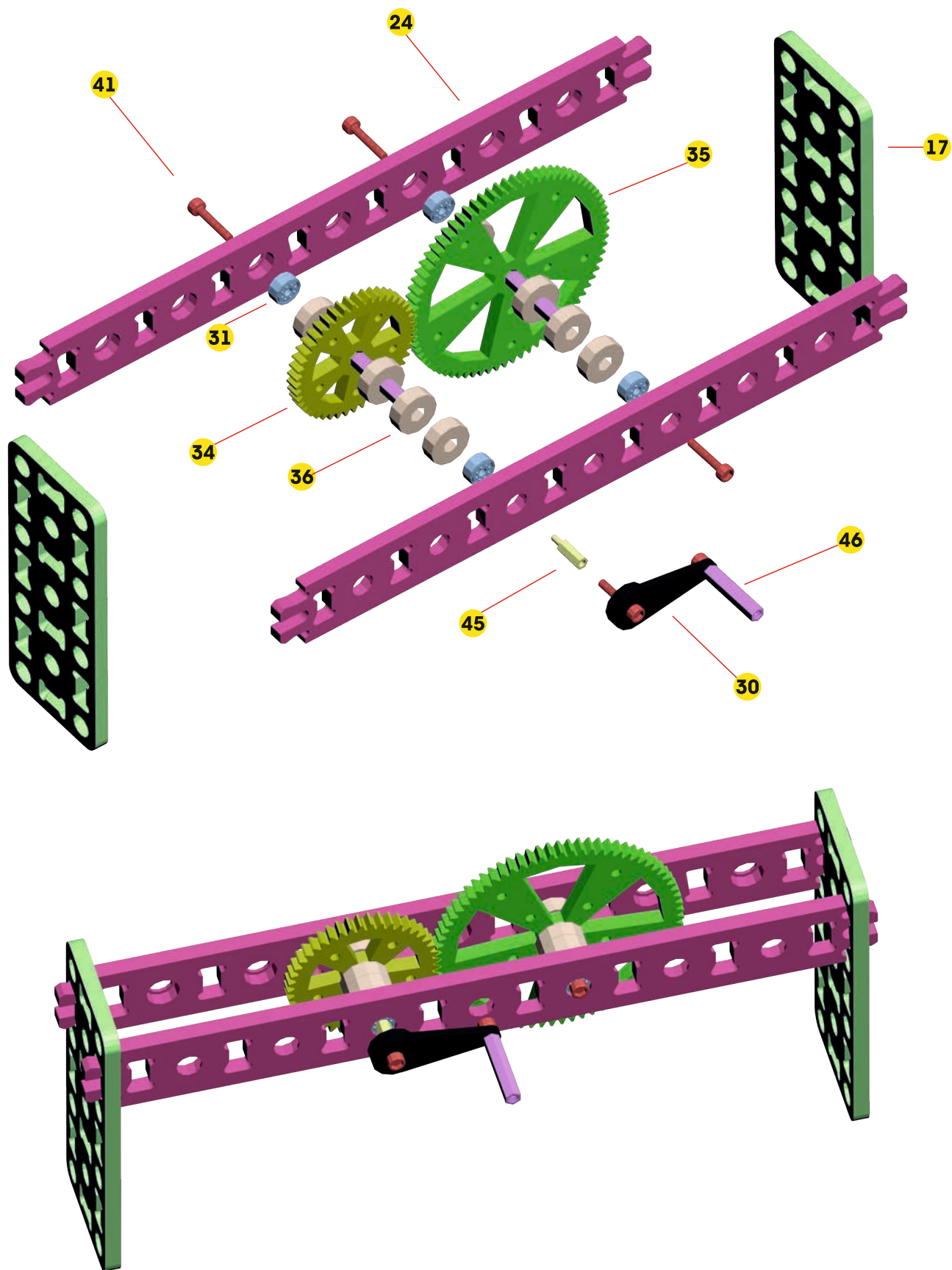

МОДЕЛЬ №15:

ОДНОСТУПЕНЧАТЫЙ РЕДУКТОР ПРОСТОЙ С МОТОРОМ

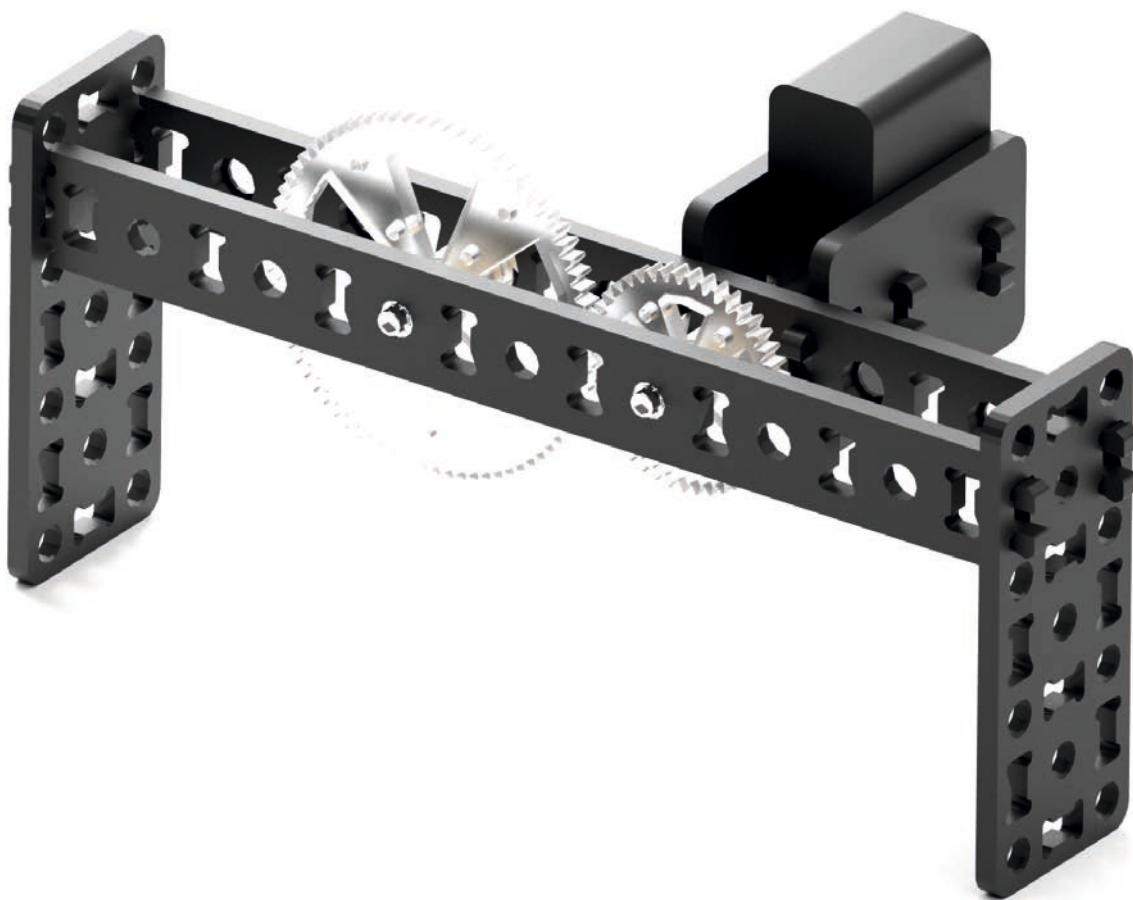

ИСПОЛЬЗУЕМЫЕ ДЕТАЛИ ДЛЯ СБОРКИ

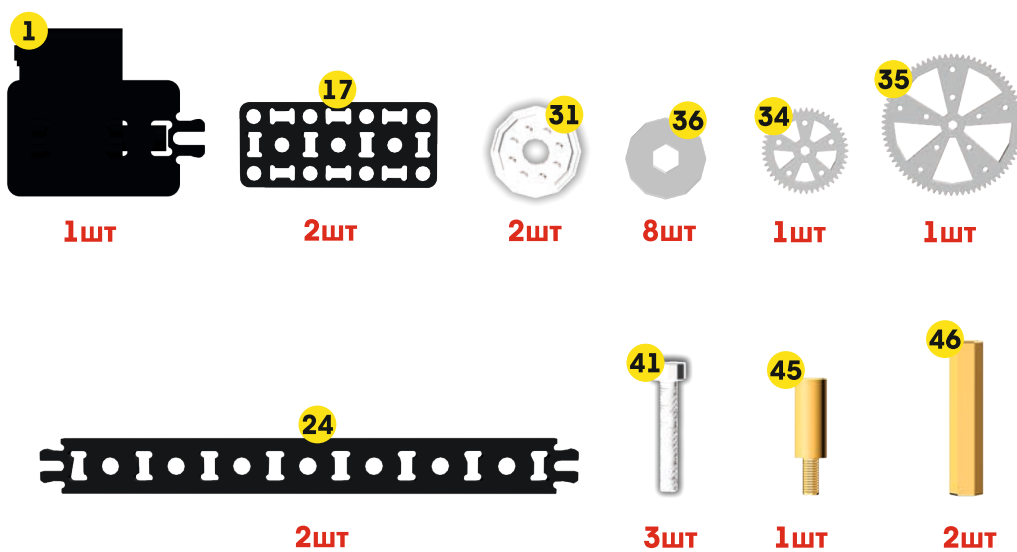

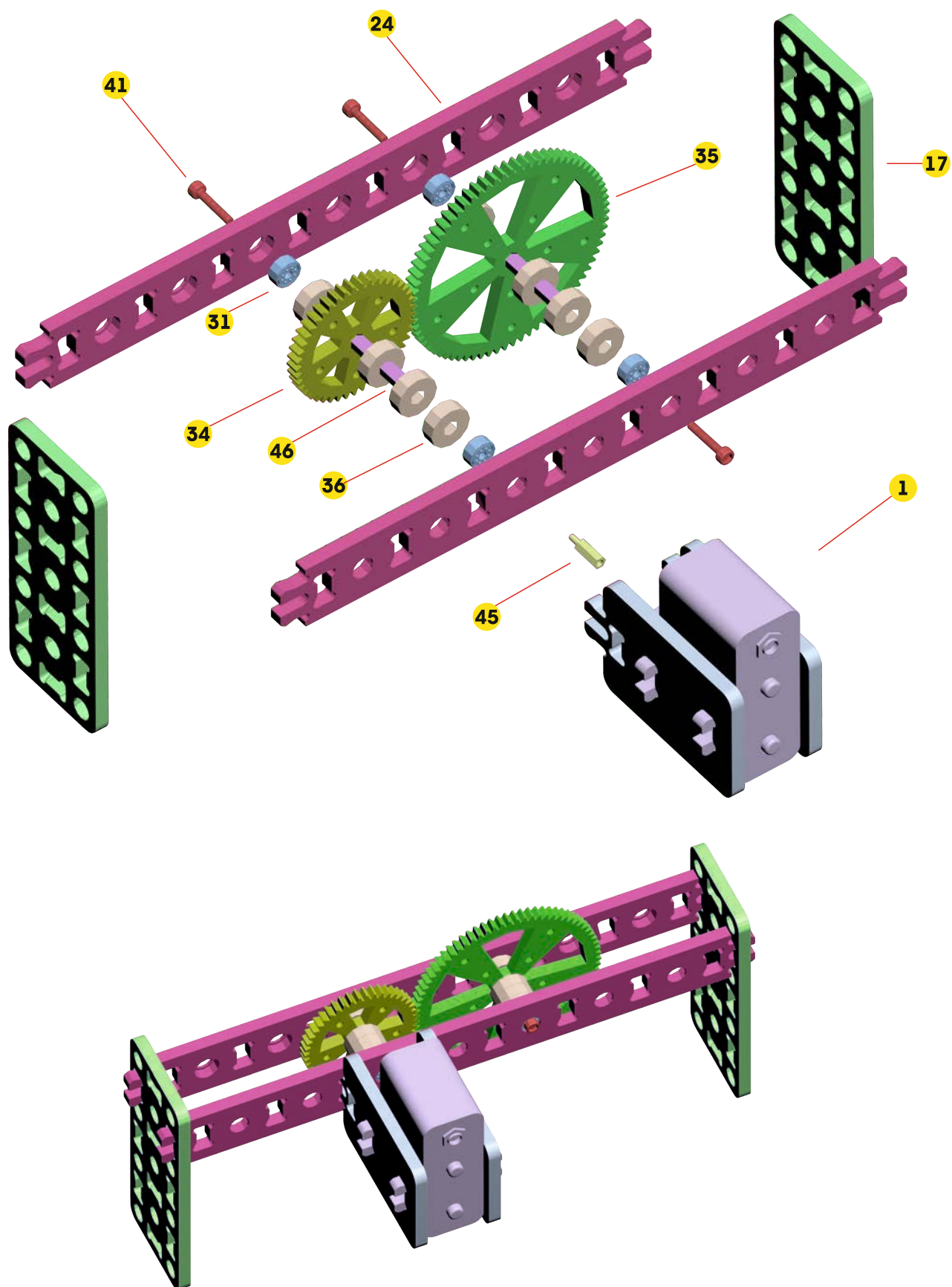

МОДЕЛЬ №2А:

ДВУХСТУПЕНЧАТЫЙ РЕДУКТОР ПО РАЗВЕРНУТОЙ СХЕМЕ

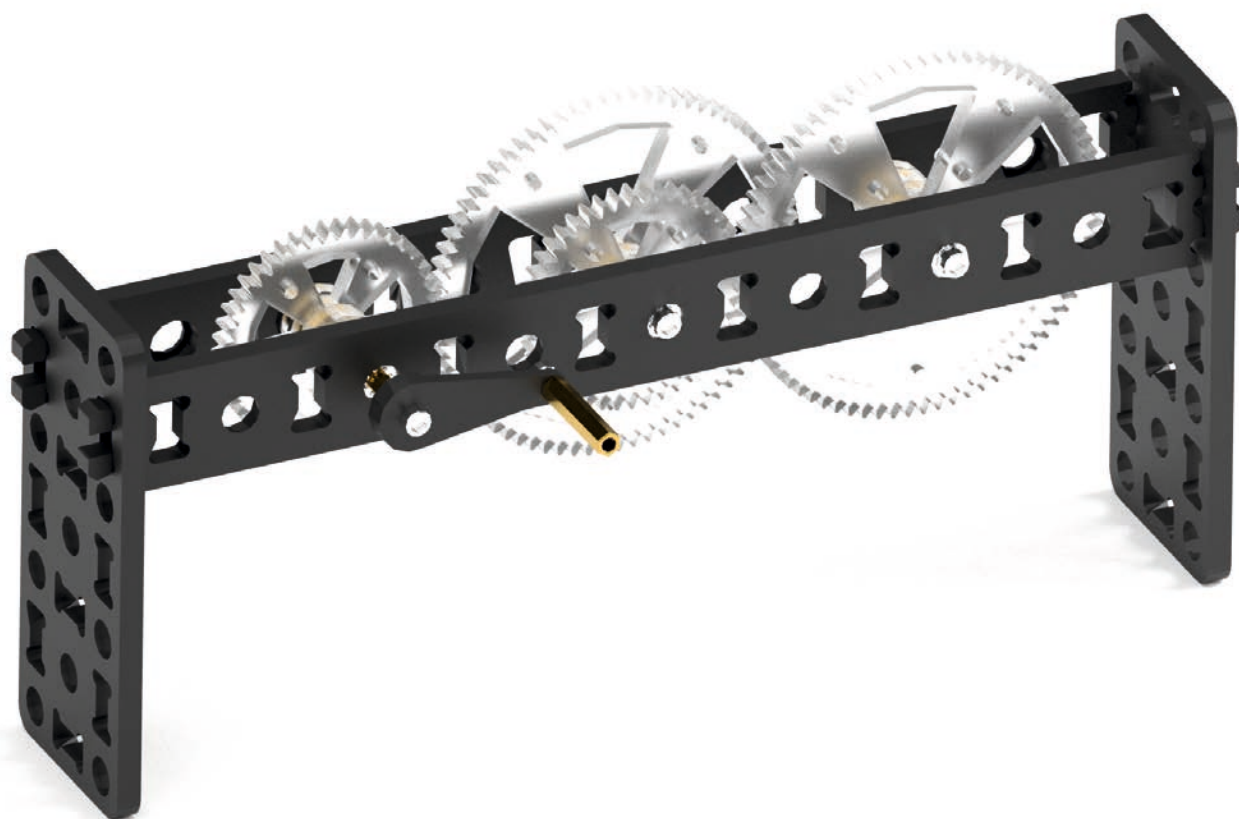

ИСПОЛЬЗУЕМЫЕ ДЕТАЛИ ДЛЯ СБОРКИ

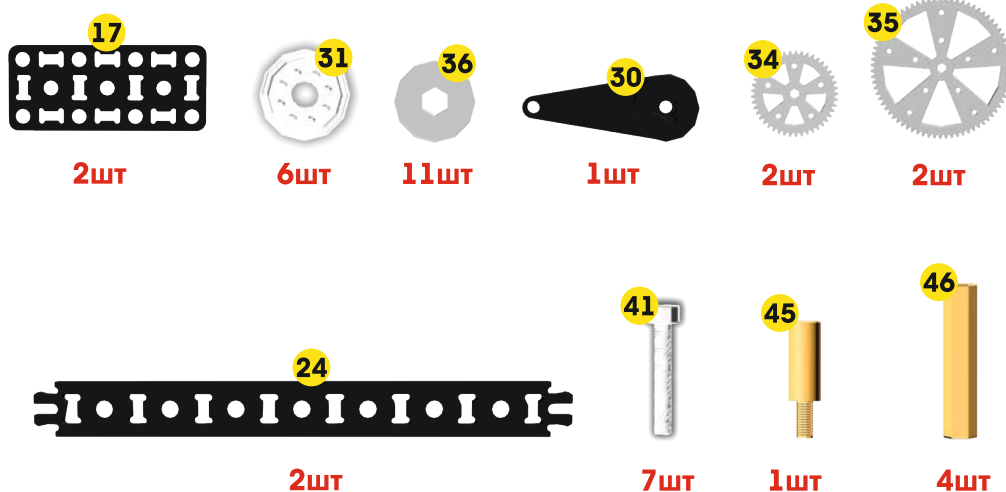

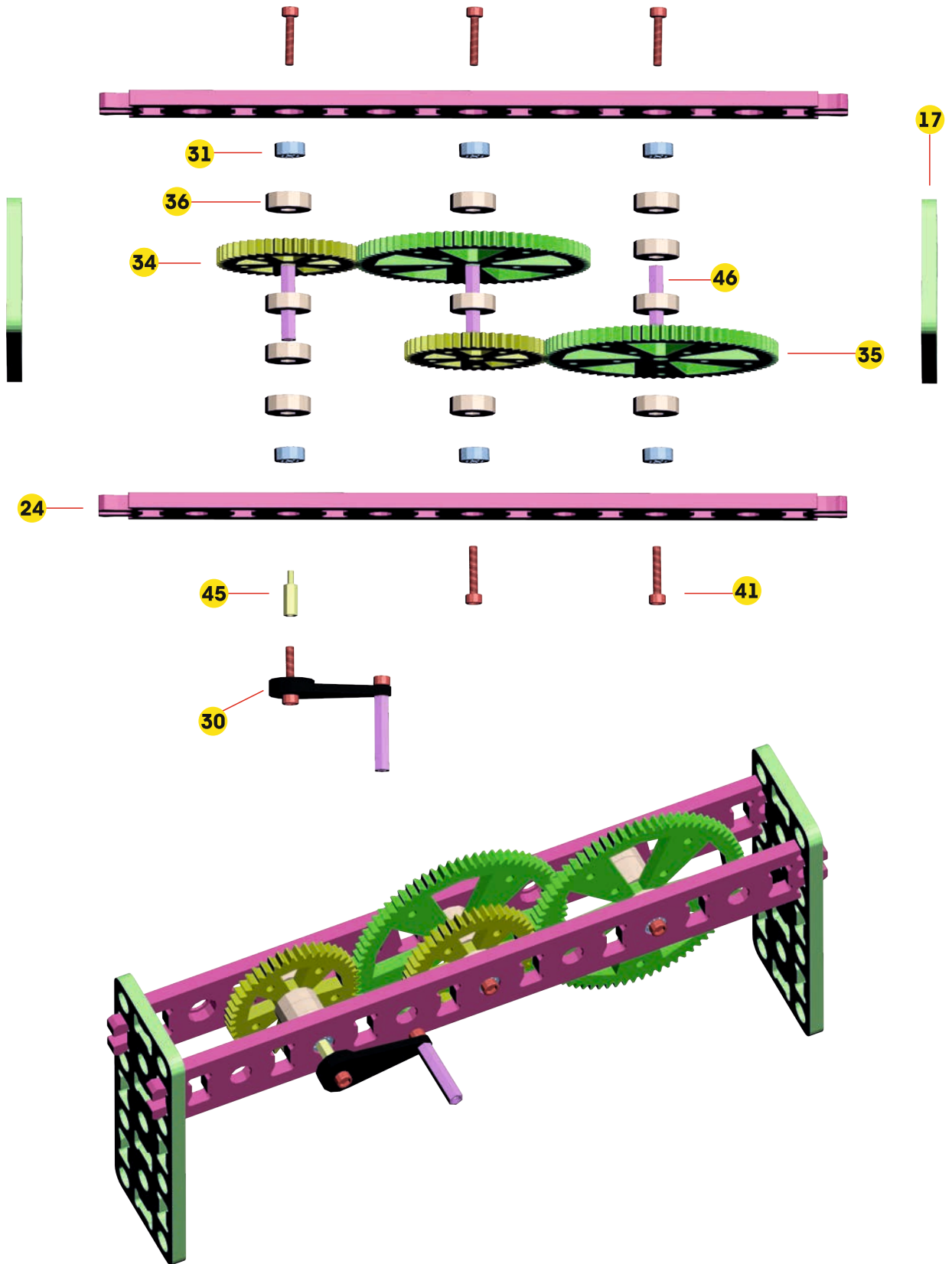

МОДЕЛЬ №25:

ДВУХСТУПЕНЧАТЫЙ РЕДУКТОР ПО РАЗВЕРНУТОЙ СХЕМЕ С МОТОРОМ

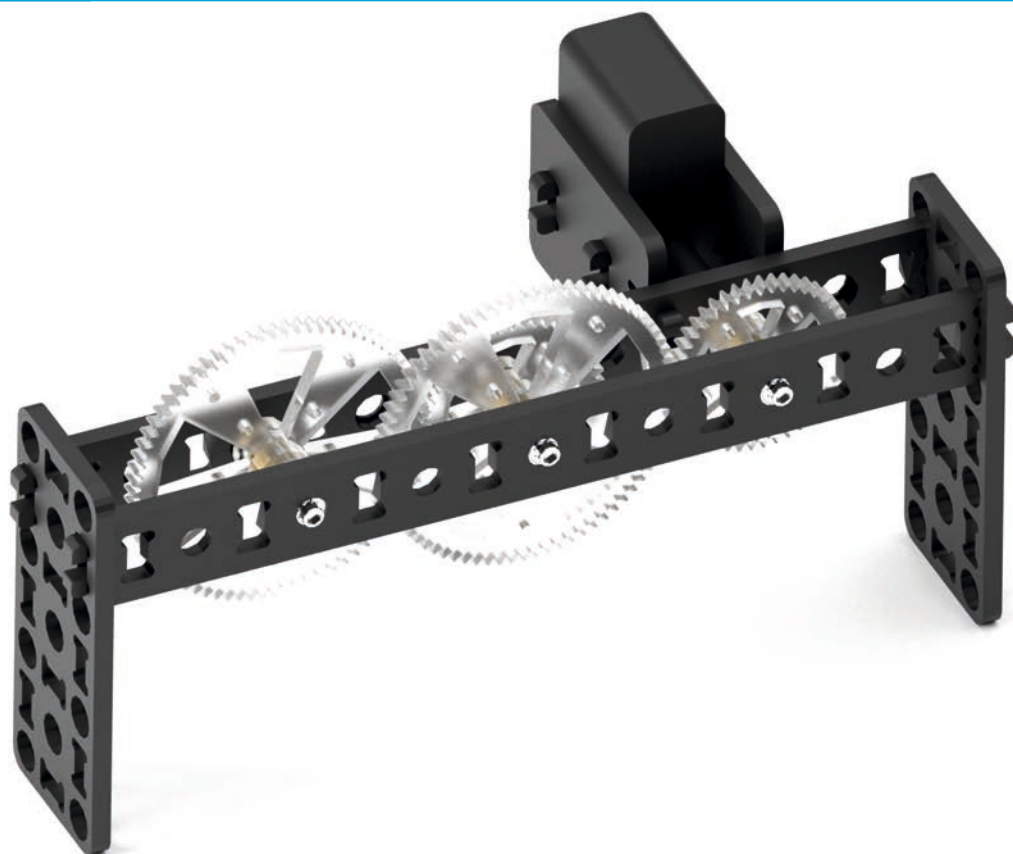

ИСПОЛЬЗУЕМЫЕ ДЕТАЛИ ДЛЯ СБОРКИ

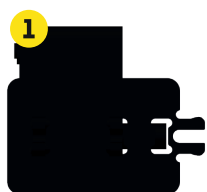

1шт

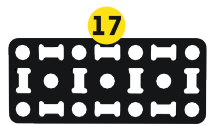

2шт



6шт



11шт



2шт



2шт



2шт



5шт



1шт



3шт

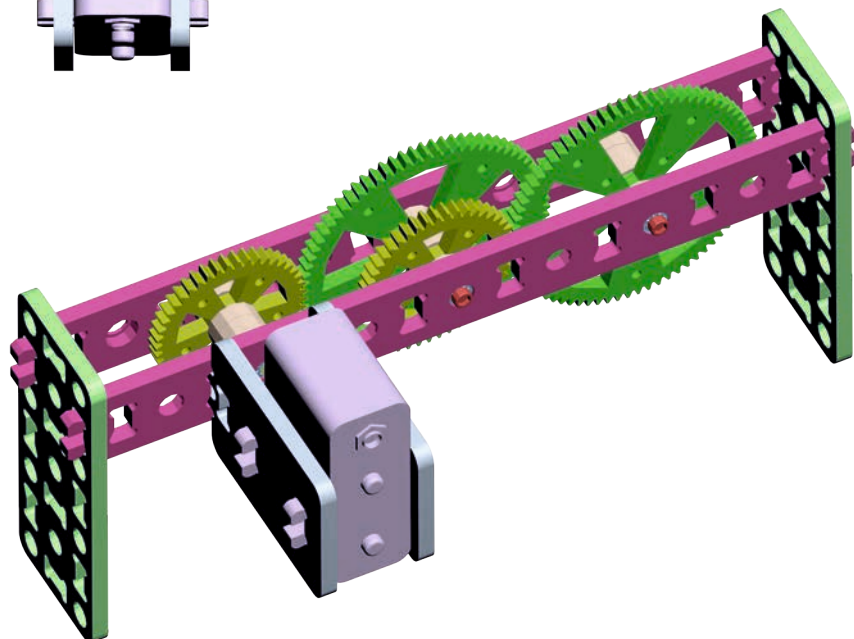
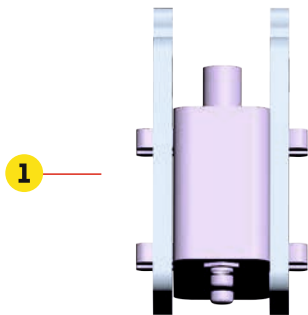
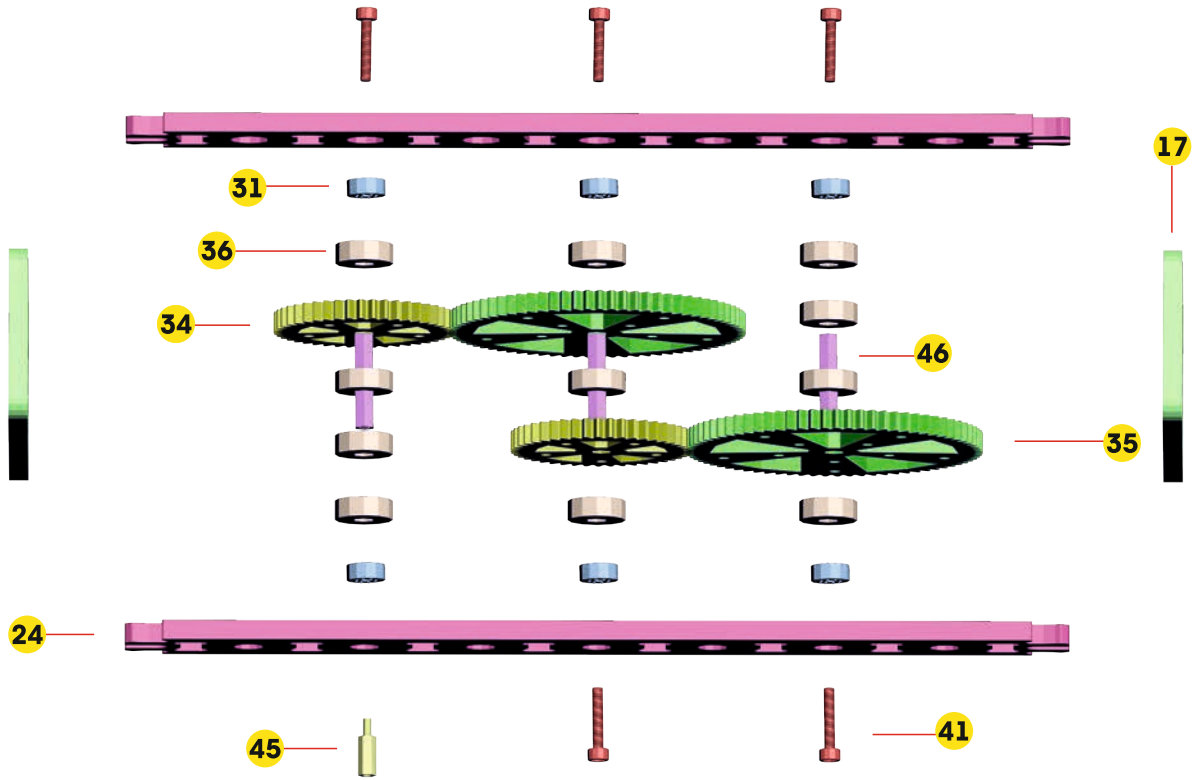

МОДЕЛЬ №3А:

ДВУХСТУПЕНЧАТЫЙ РЕДУКТОР С РАЗДВОЕННОЙ БЫСТРОХОДНОЙ СТУПЕНЬЮ

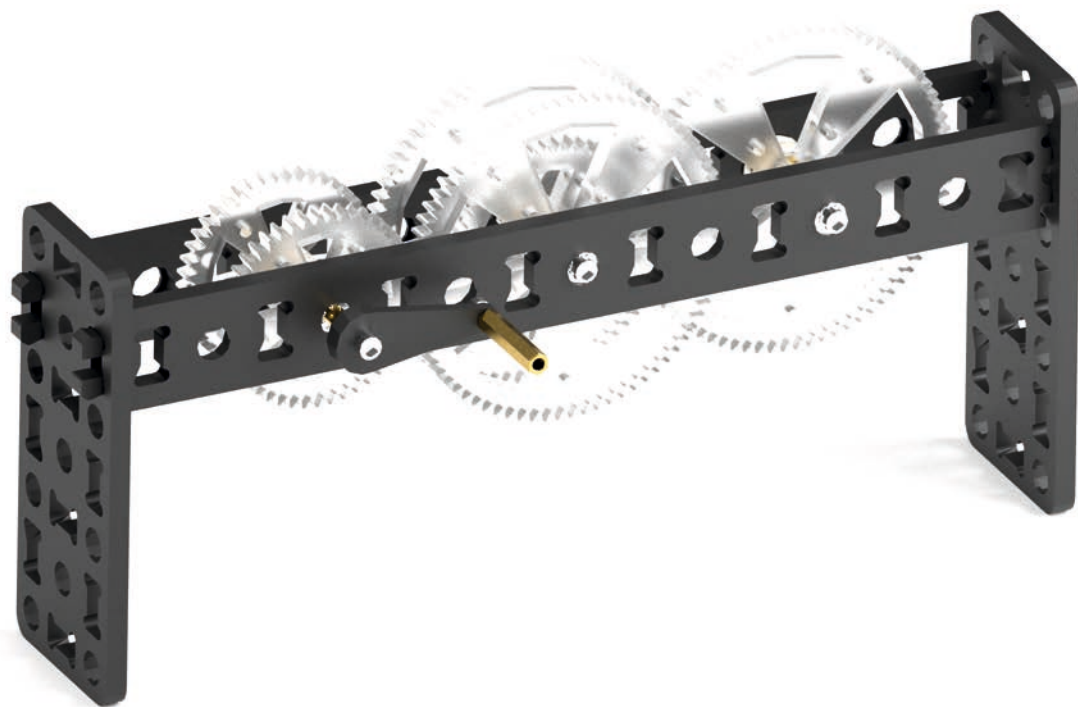

ИСПОЛЬЗУЕМЫЕ ДЕТАЛИ ДЛЯ СБОРКИ



2шт



6шт



9шт



1шт



3шт



3шт



2шт



7шт



1шт



4шт

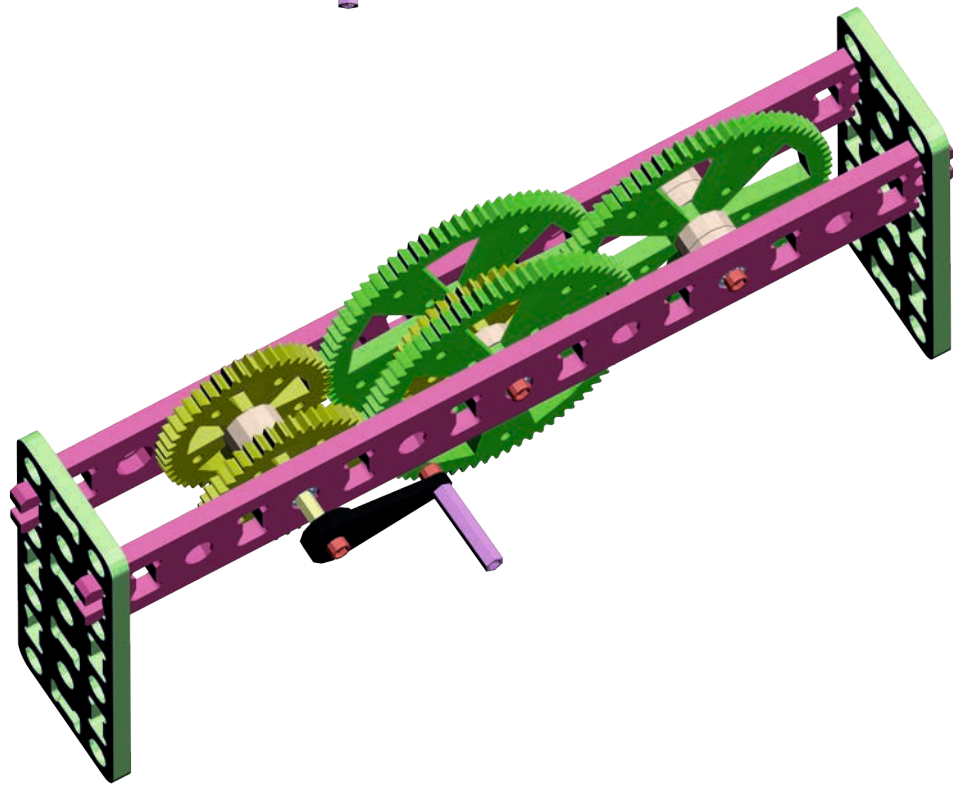
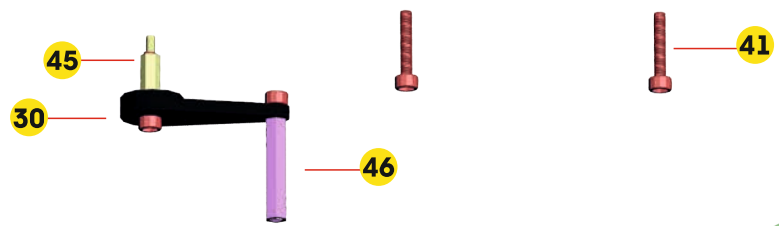
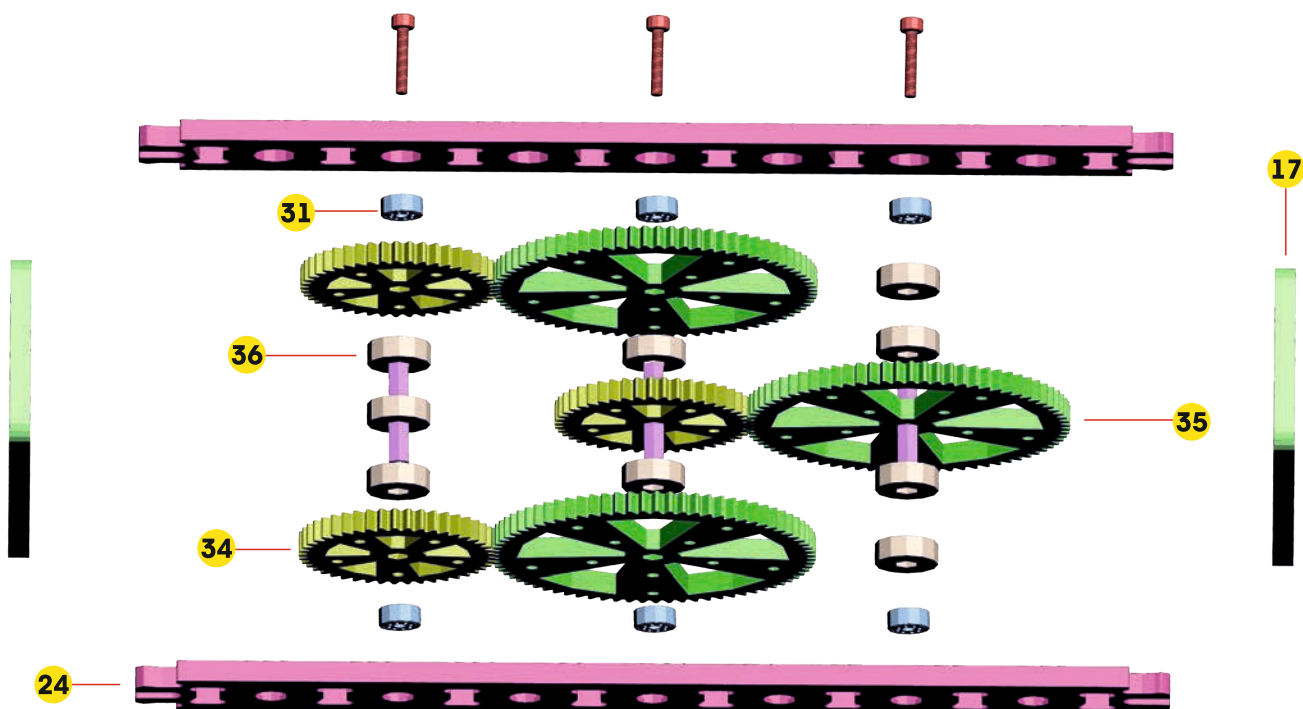

МОДЕЛЬ №35:

ДВУХСТУПЕНЧАТЫЙ РЕДУКТОР С РАЗДВОЕННОЙ БЫСТРОХОДНОЙ СТУПЕНЬЮ С МОТОРОМ



ИСПОЛЬЗУЕМЫЕ ДЕТАЛИ ДЛЯ СБОРКИ

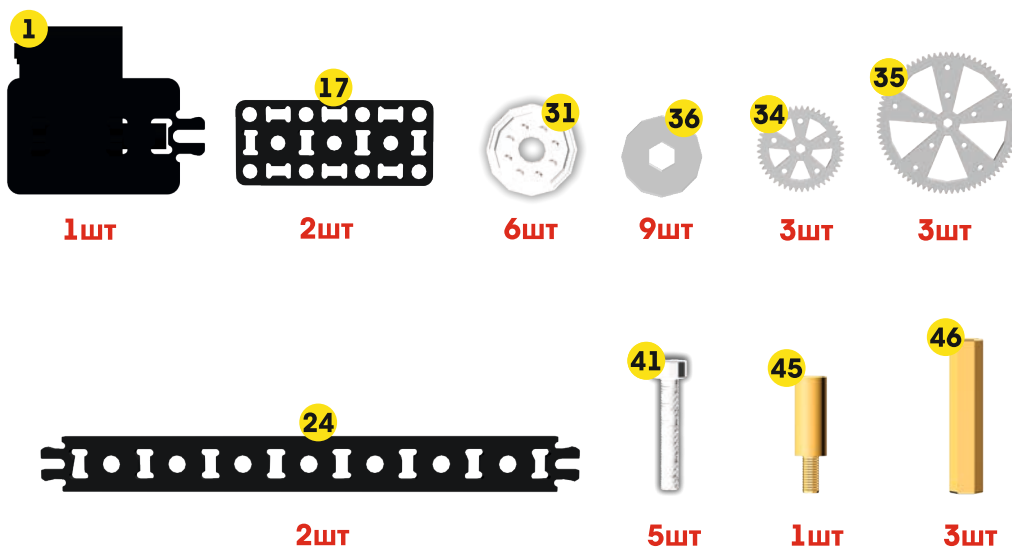

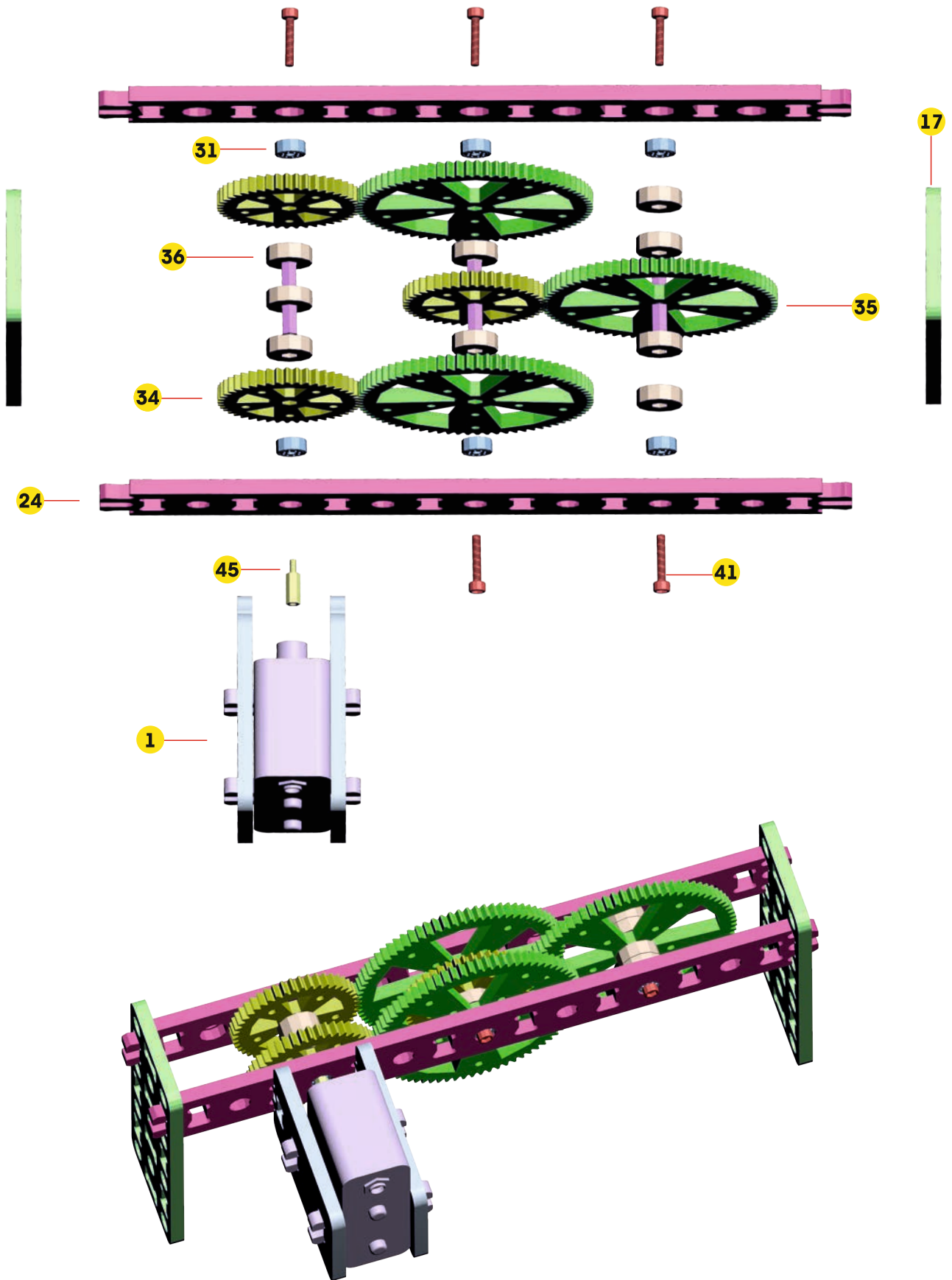

МОДЕЛЬ №4А:

ДВУХСТУПЕНЧАТЫЙ РЕДУКТОР С РАЗДВОЕННОЙ ТИХОХОДНОЙ СТУПЕНЬЮ

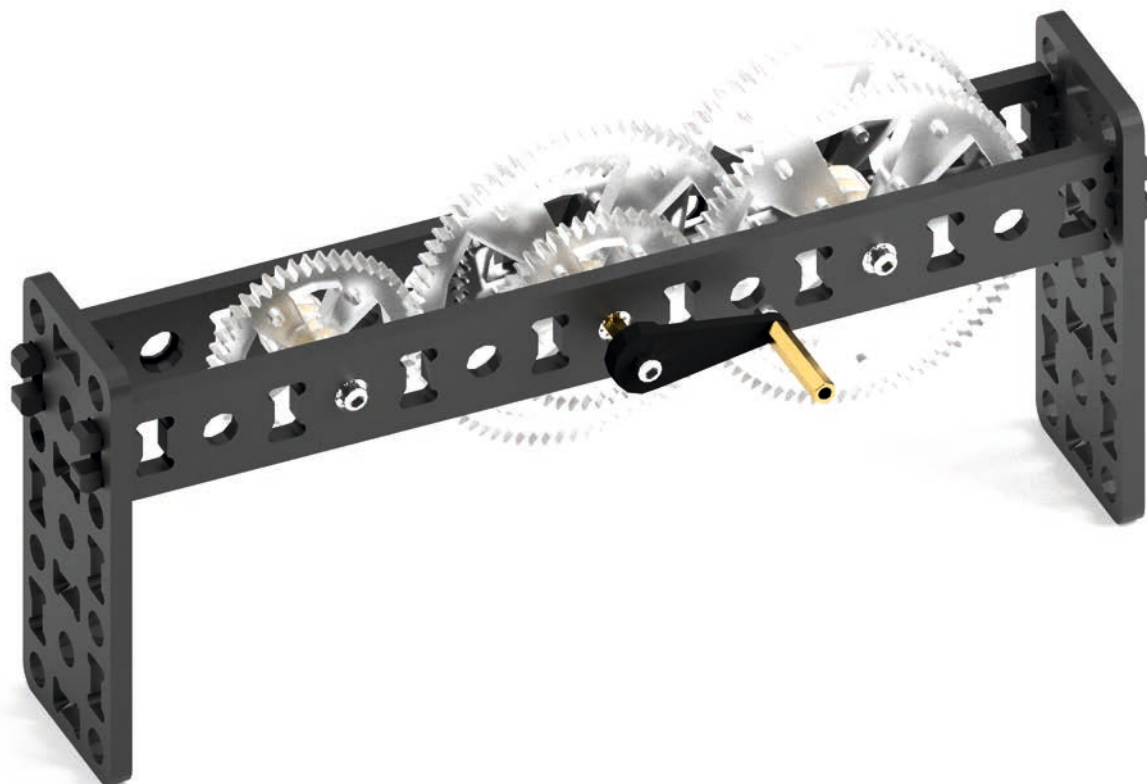

ИСПОЛЬЗУЕМЫЕ ДЕТАЛИ ДЛЯ СБОРКИ

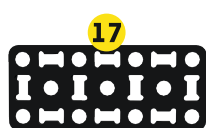

2шт



6шт



9шт



1шт



3шт



3шт



2шт



7шт



1шт



4шт

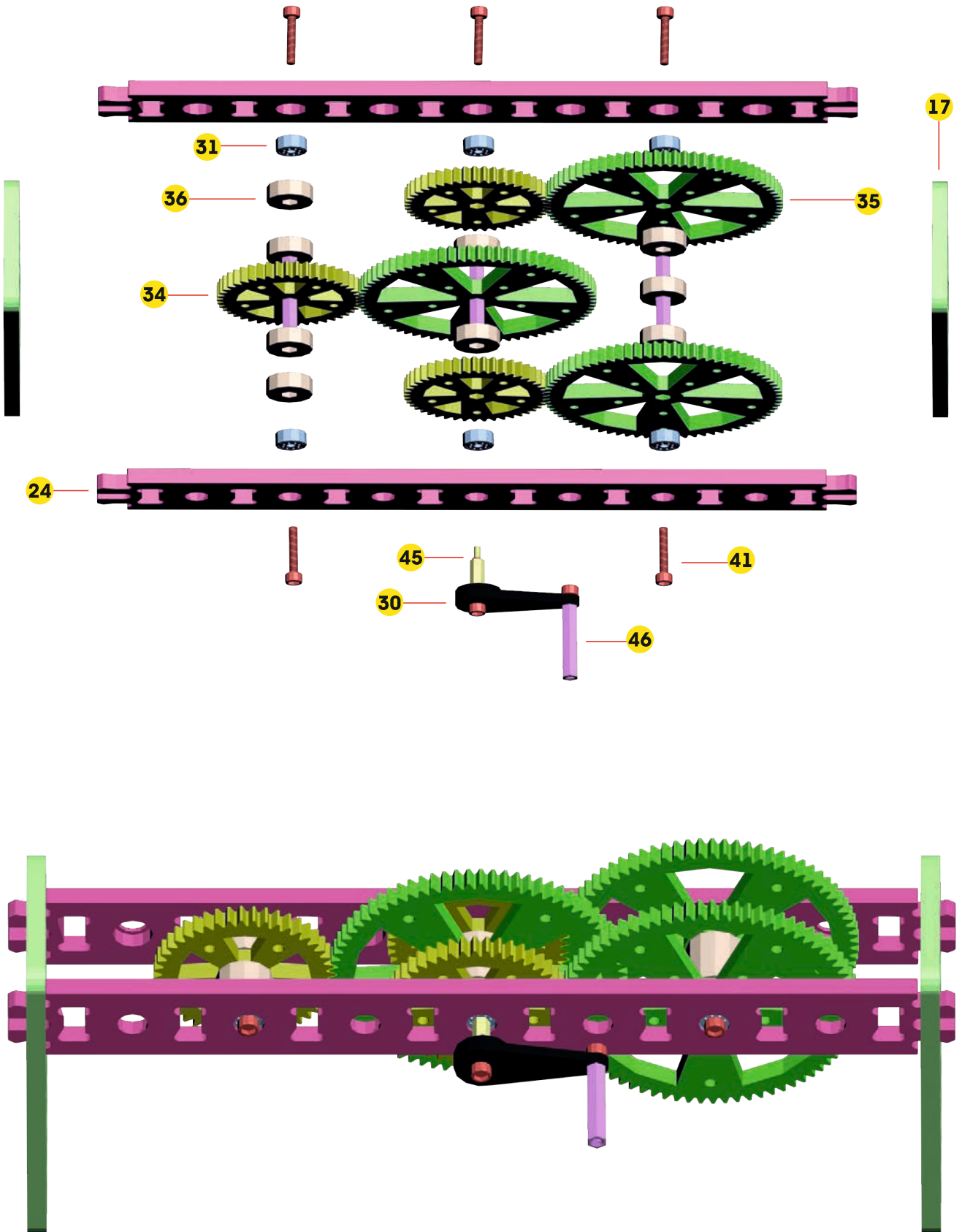

МОДЕЛЬ №4Б:

ДВУХСТУПЕНЧАТЫЙ РЕДУКТОР С РАЗДВОЕННОЙ ТИХОХОДНОЙ СТУПЕНЬЮ С МОТОРОМ

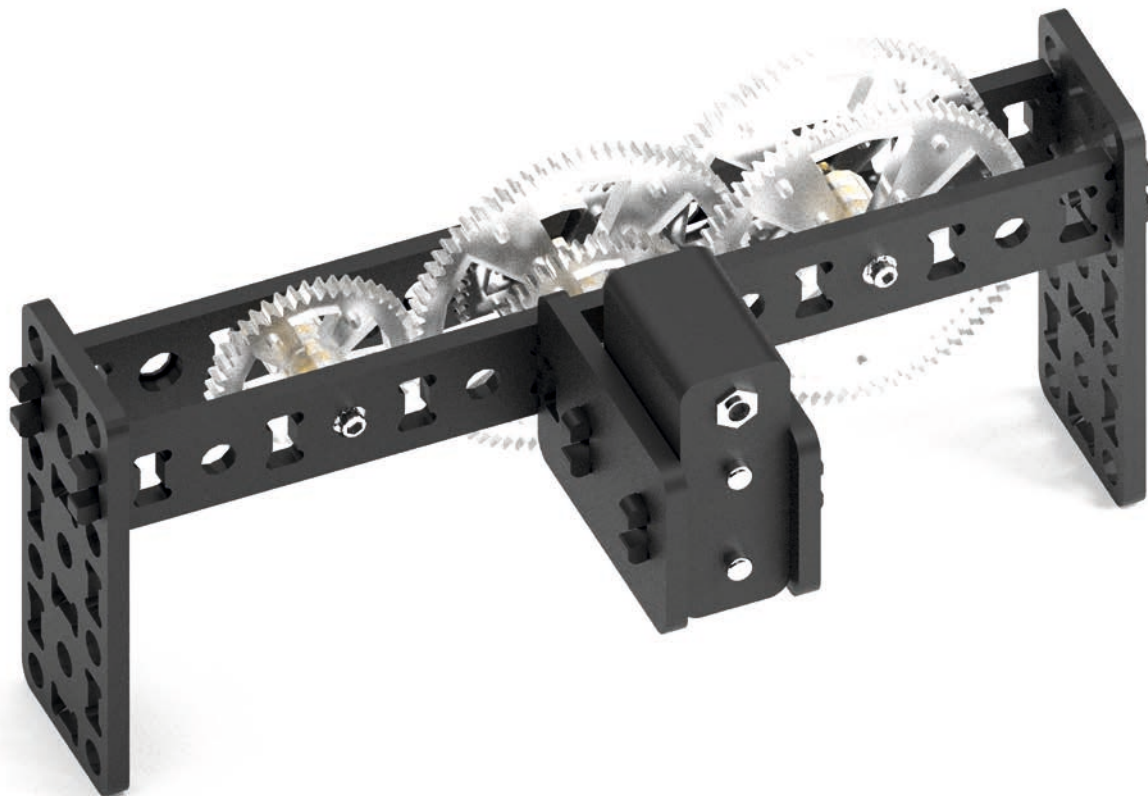

ИСПОЛЬЗУЕМЫЕ ДЕТАЛИ ДЛЯ СБОРКИ

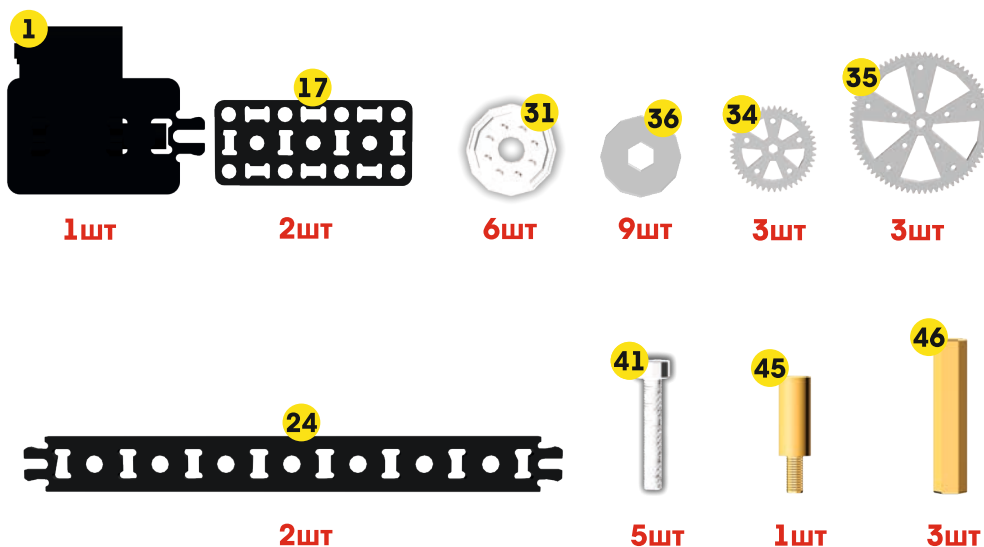

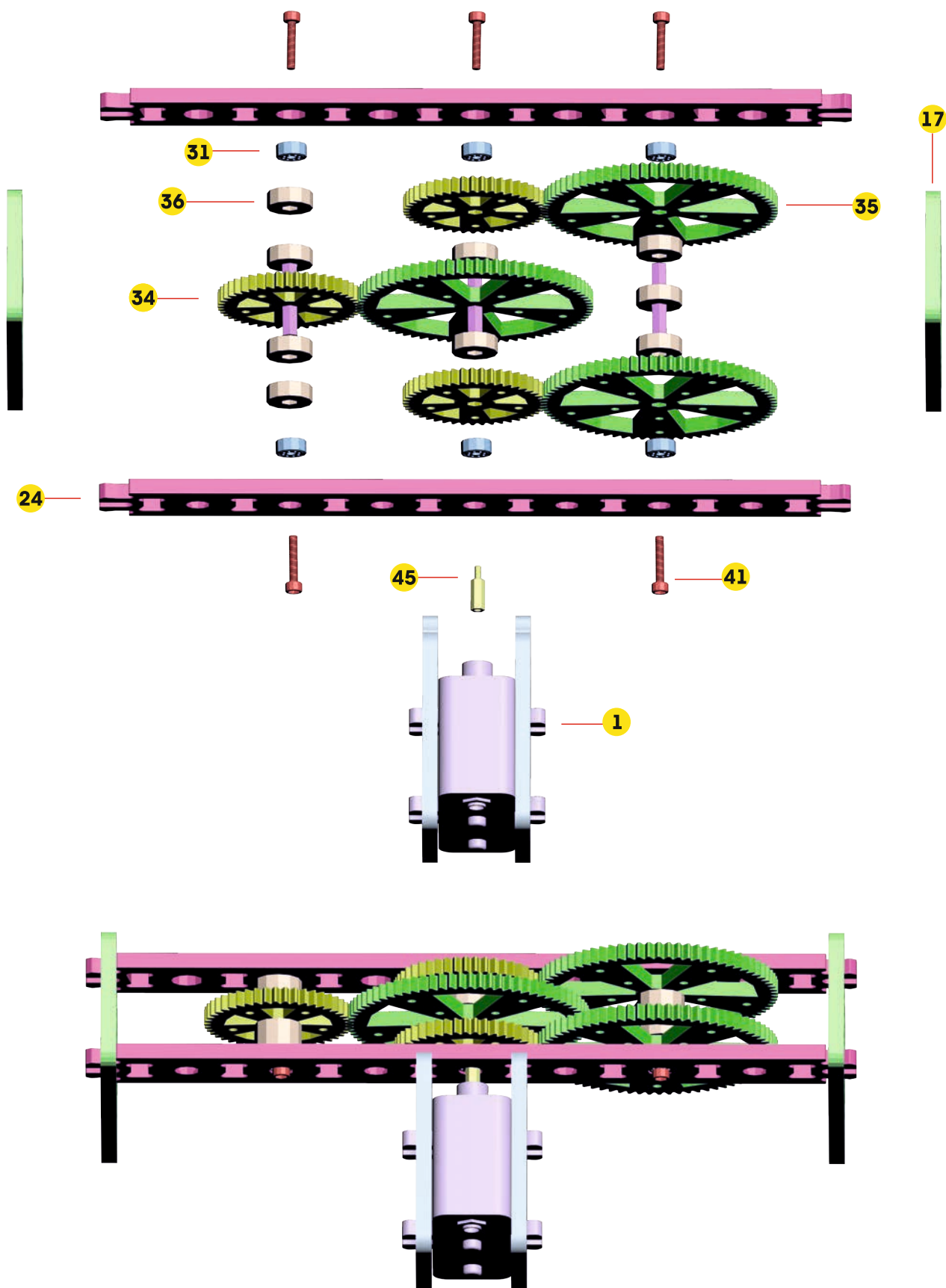

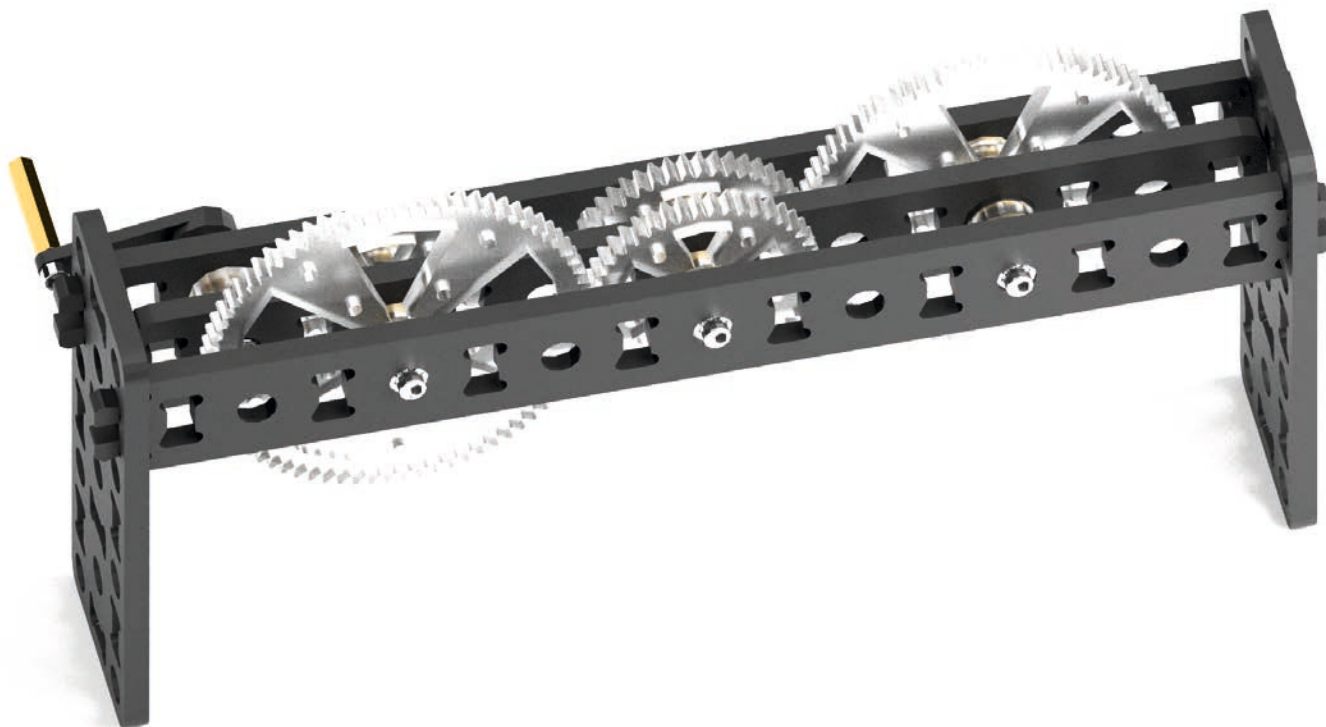

ИСПОЛЬЗУЕМЫЕ ДЕТАЛИ ДЛЯ СБОРКИ



2шт



8шт



8шт



1шт



3шт



2шт



1шт



9шт



2шт



1шт



1шт



5шт

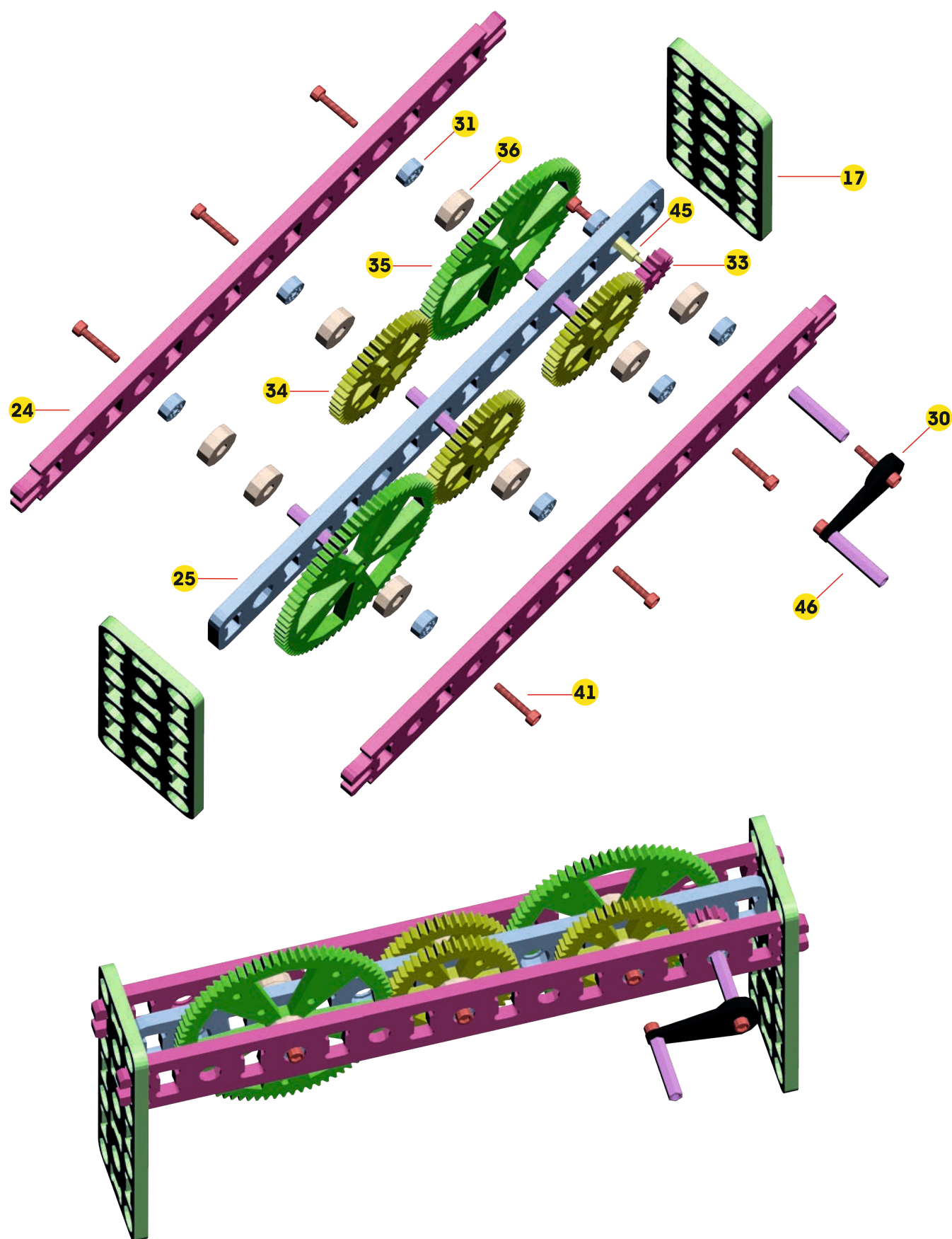

МОДЕЛЬ №5Б:

ТРЕХСТУПЕНЧАТЫЙ РЕДУКТОР С МОТОРОМ



ИСПОЛЬЗУЕМЫЕ ДЕТАЛИ ДЛЯ СБОРКИ

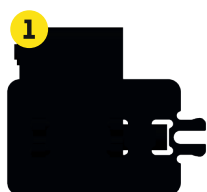

1 шт

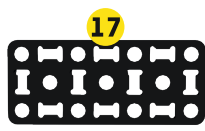

2 шт



8 шт



8 шт



3 шт

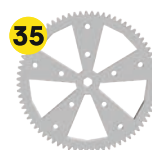

2 шт



1 шт



7 шт



2 шт



1 шт



1 шт



4 шт

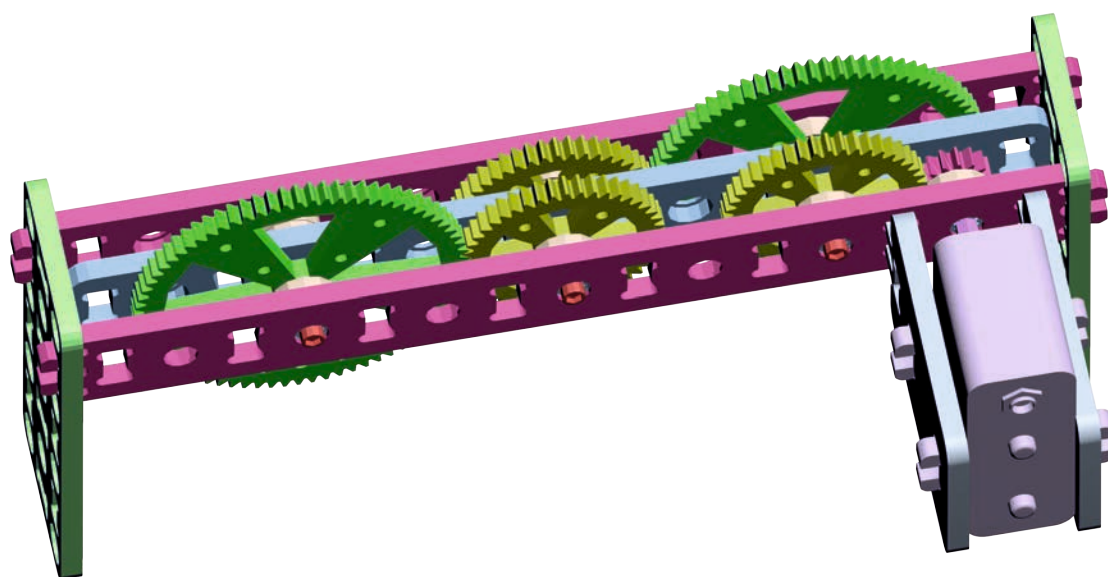
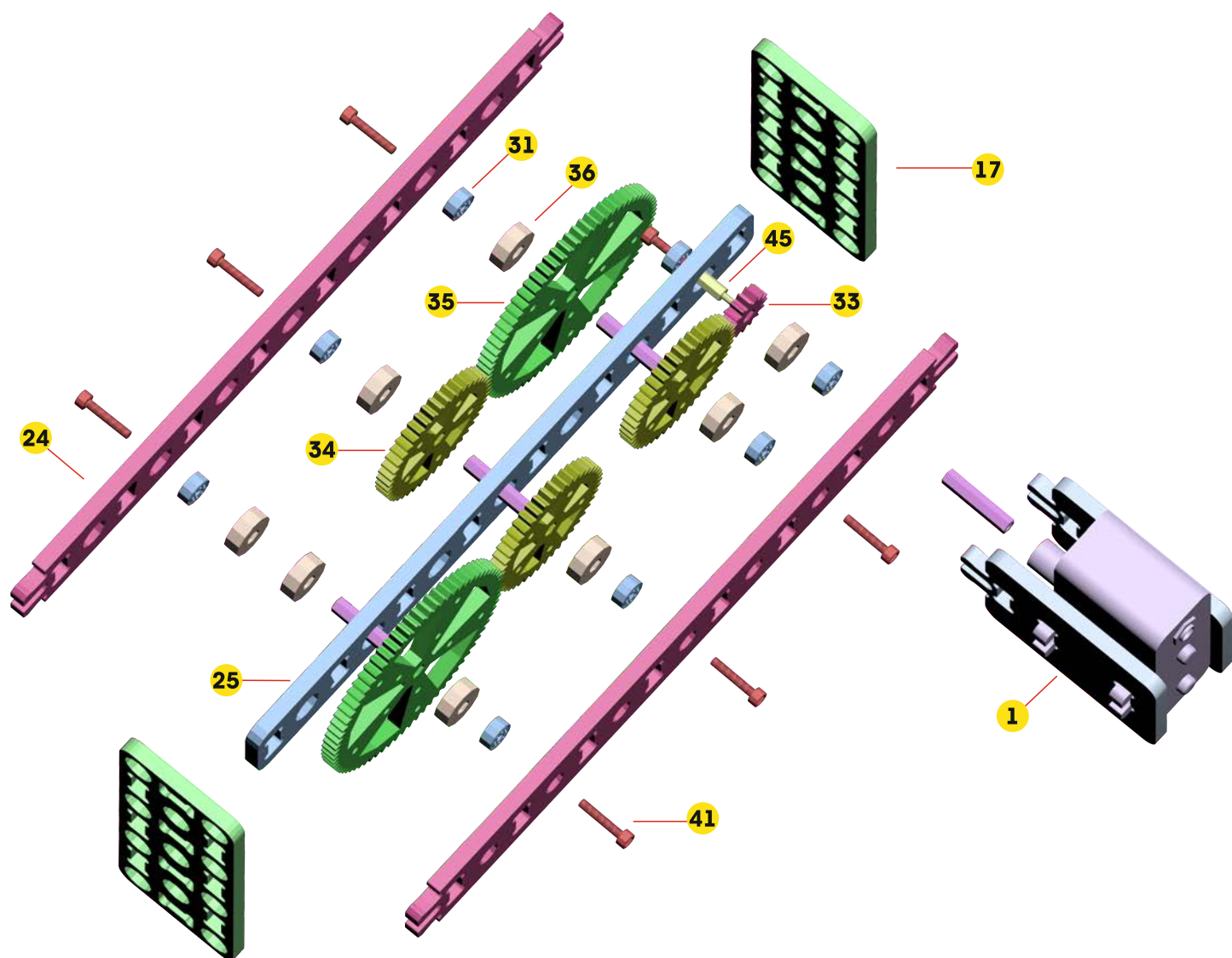

МОДЕЛЬ №6А:

МНОГОСТУПЕНЧАТЫЙ КОМБИНИРОВАННЫЙ РЕДУКТОР (РЕМЕННАЯ ПЕРЕДАЧА+ШЕСТЕРНИ)

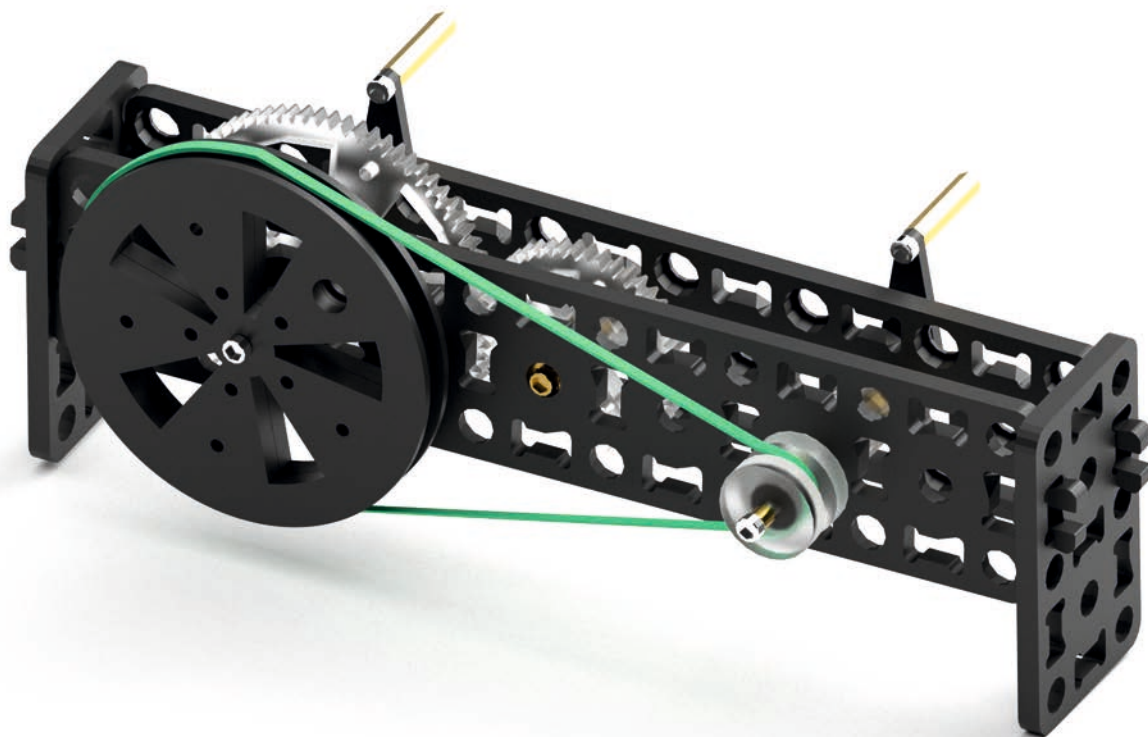

ИСПОЛЬЗУЕМЫЕ ДЕТАЛИ ДЛЯ СБОРКИ

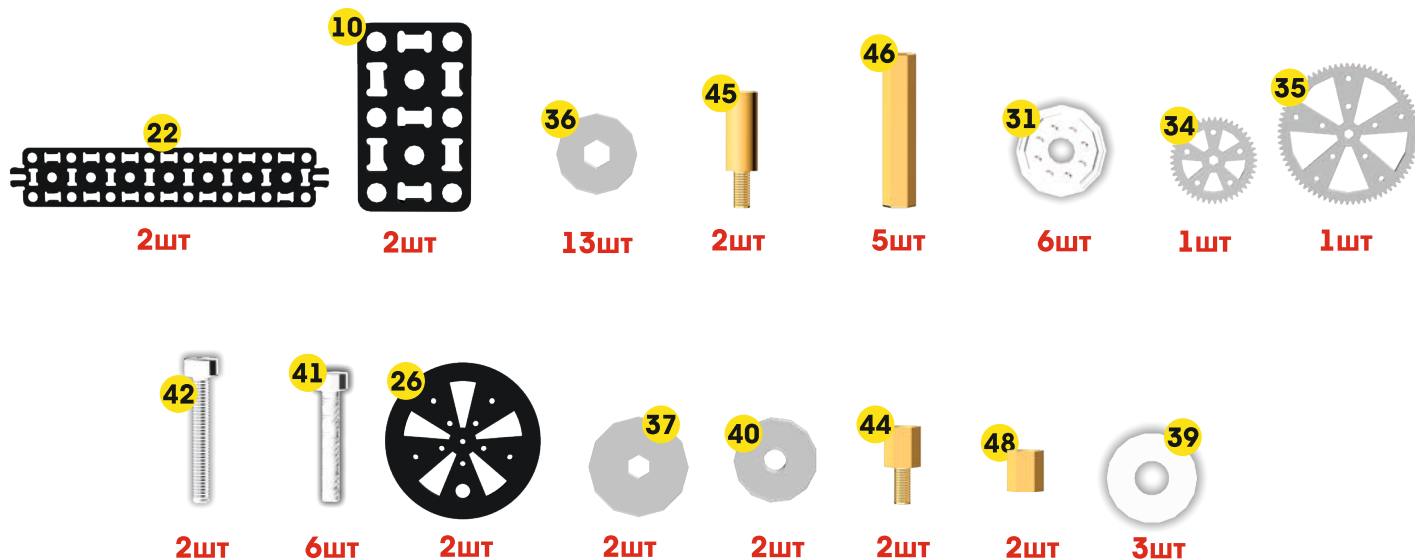

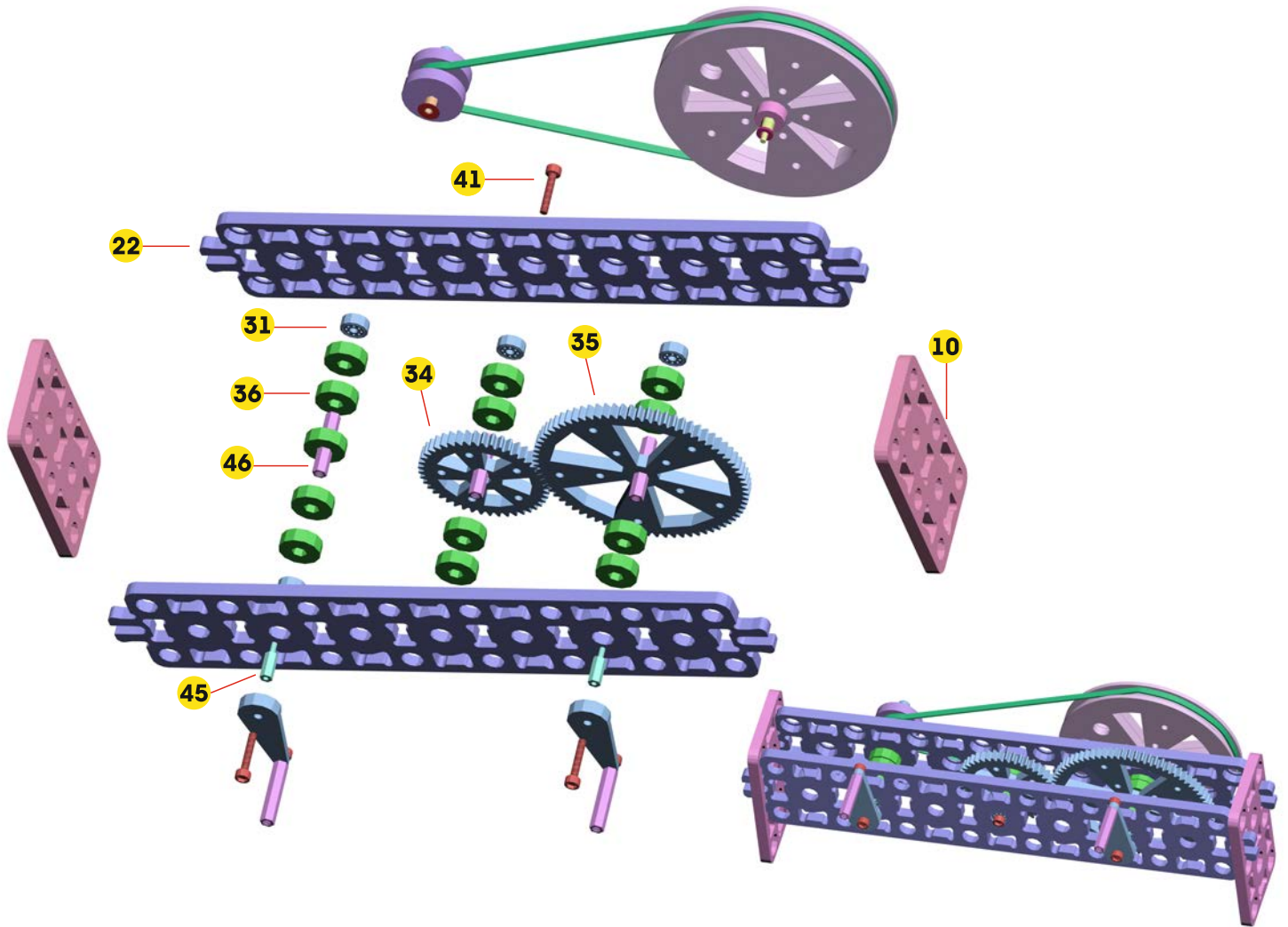

БОРКА ШКИВОВ:

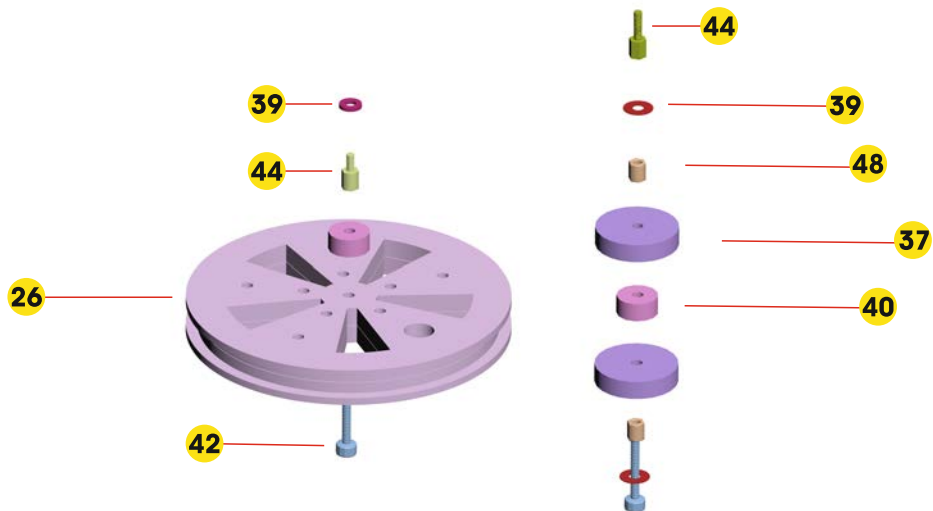

МОДЕЛЬ №65:

МНОГОСТУПЕНЧАТЫЙ КОМБИНИРОВАННЫЙ РЕДУКТОР (РЕМЕННАЯ ПЕРЕДАЧА+ШЕСТЕРНИ) С МОТОРОМ

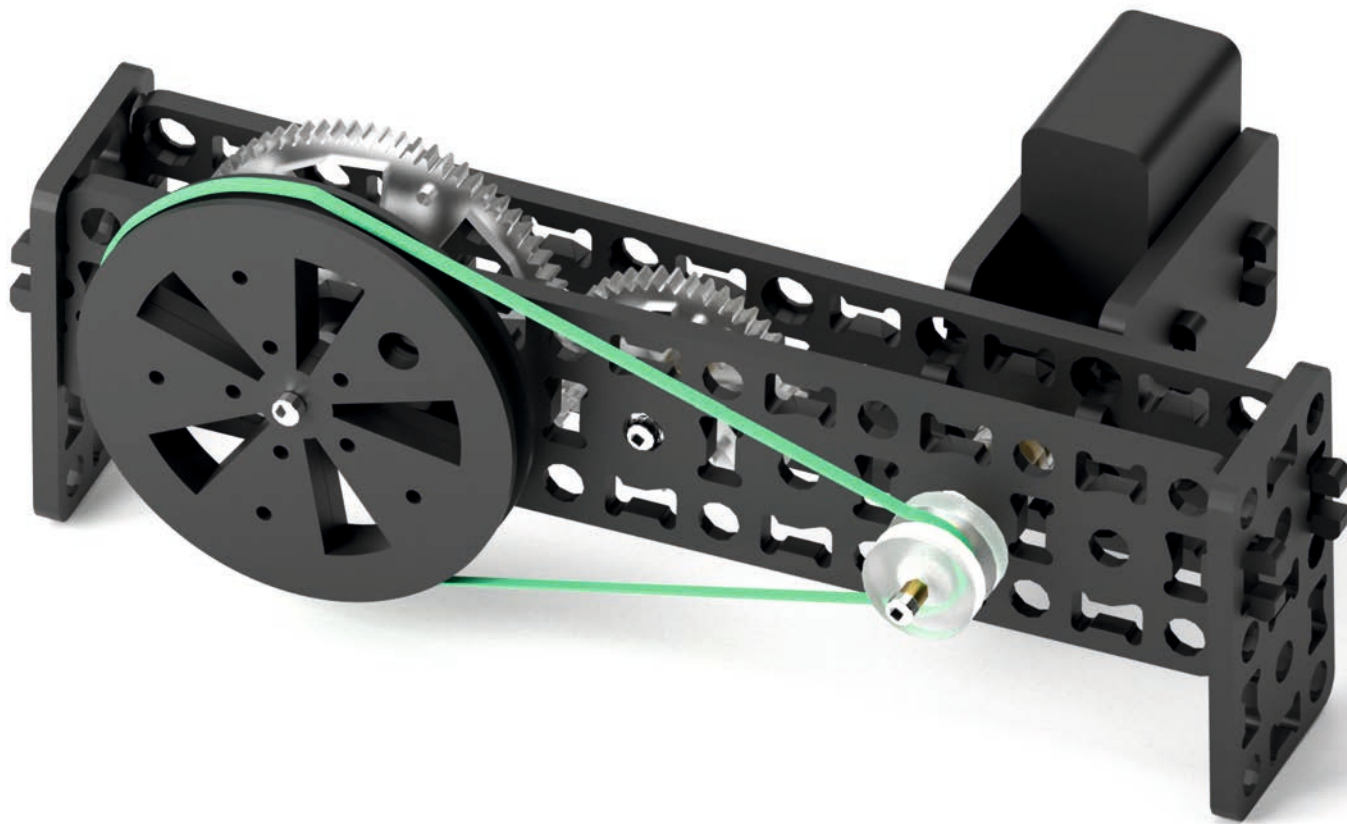

ИСПОЛЬЗУЕМЫЕ ДЕТАЛИ ДЛЯ СБОРКИ

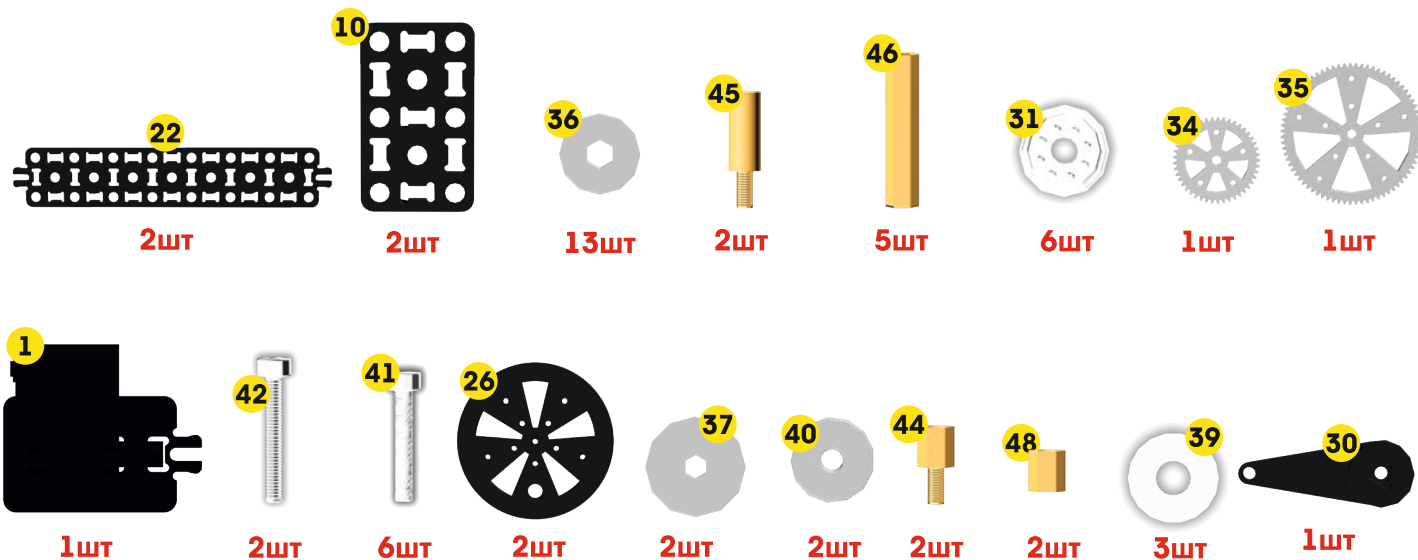

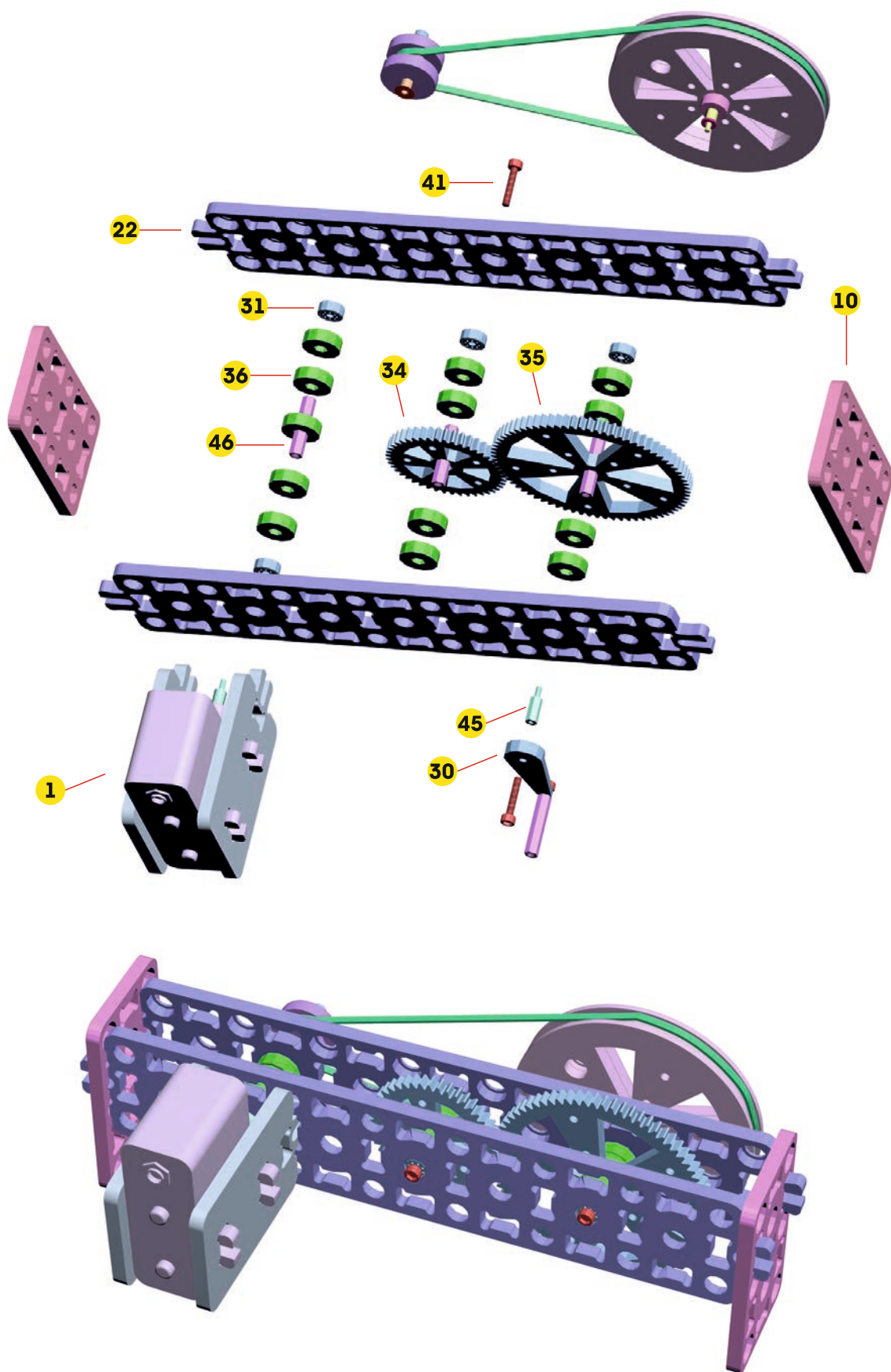

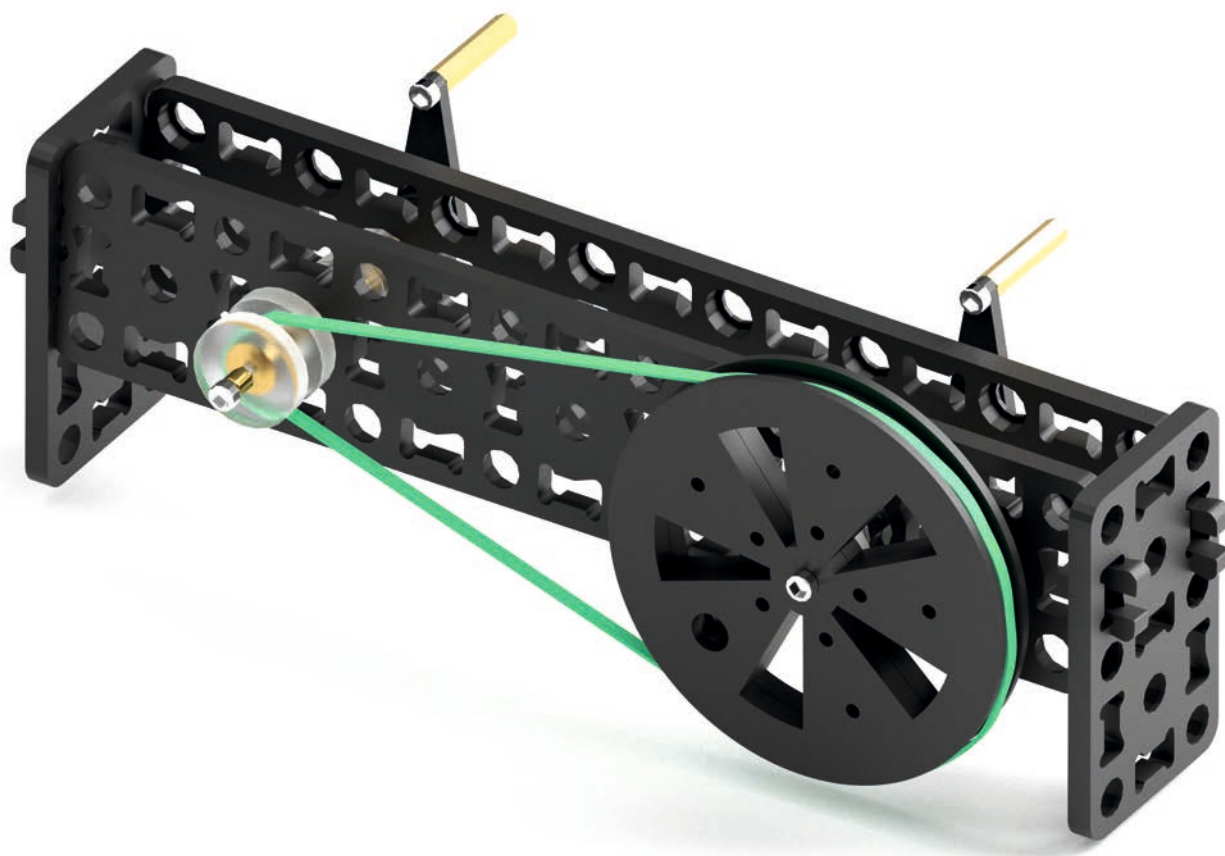

ИСПОЛЬЗУЕМЫЕ ДЕТАЛИ ДЛЯ СБОРКИ

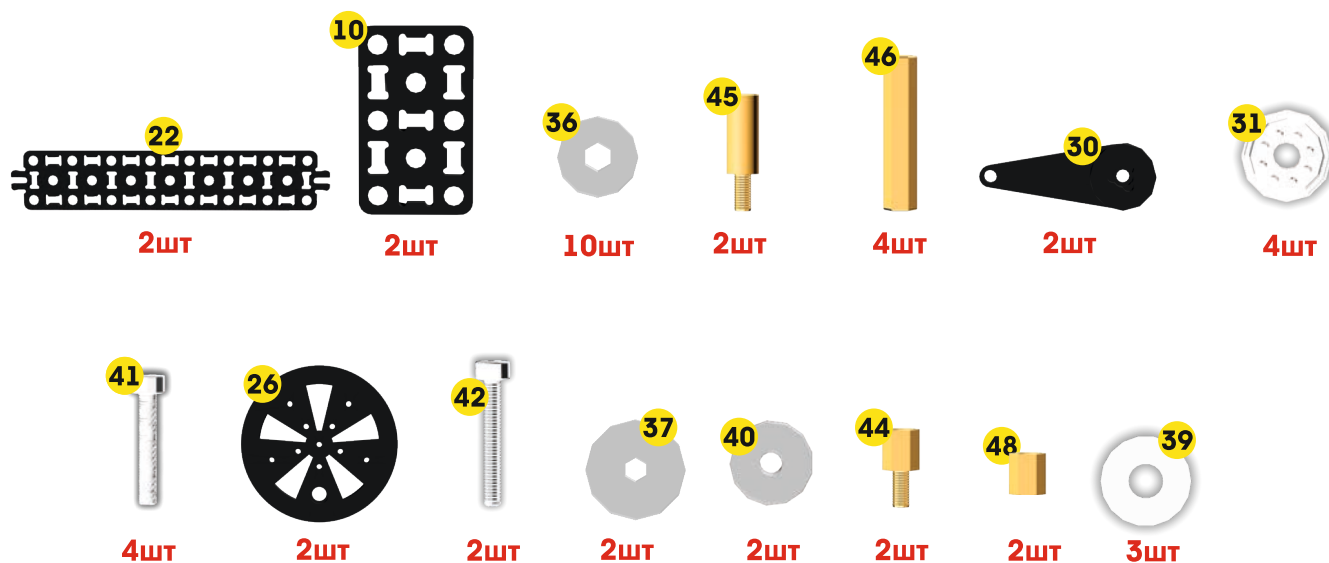

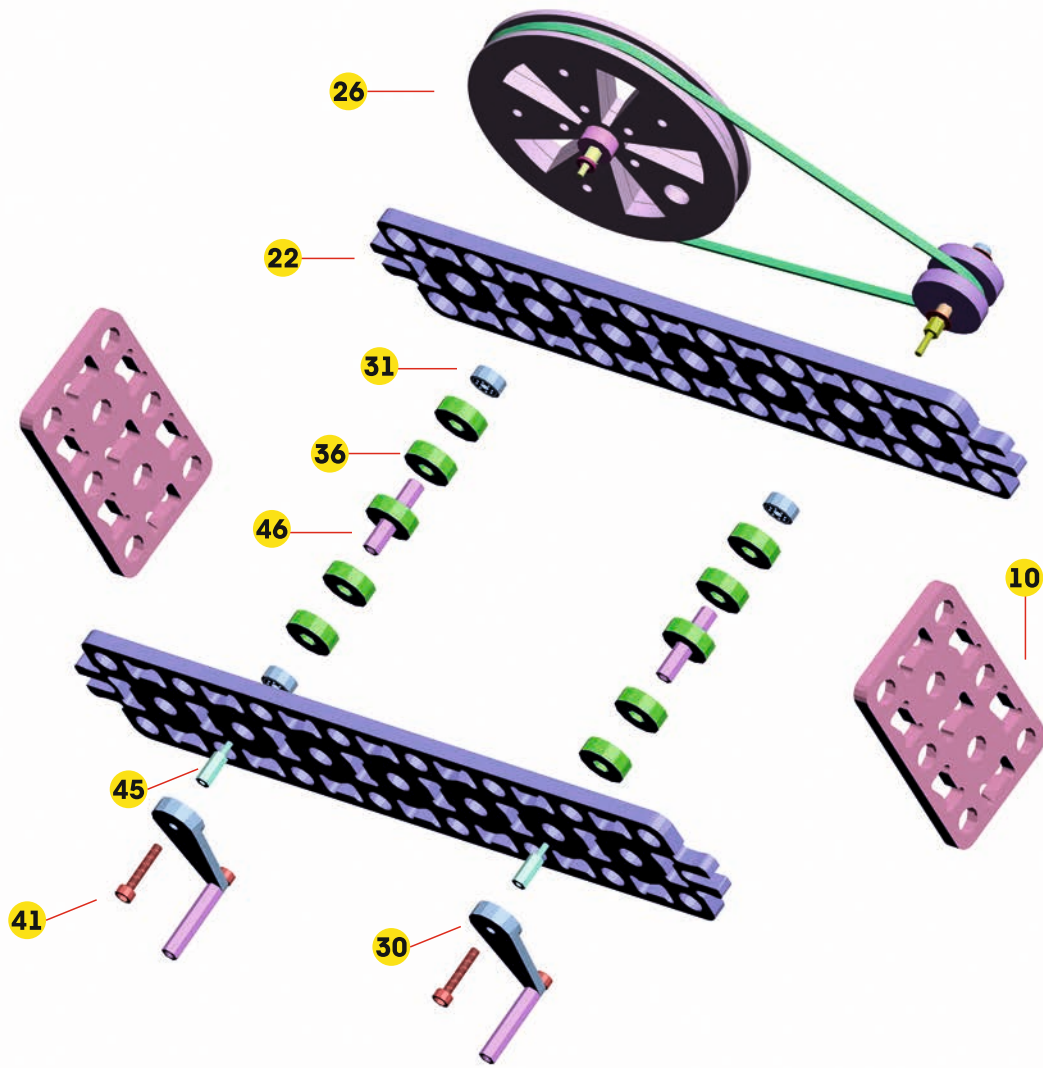

БОРКА ШКИВОВ:

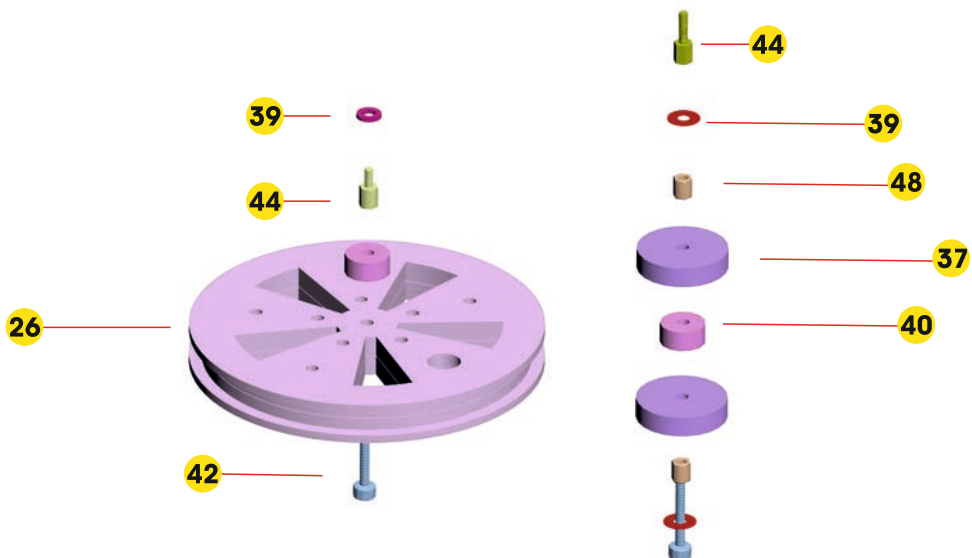

МОДЕЛЬ №7Б:

ОДНОСТУПЕЧАТЫЙ РЕДУКТОР (РЕМЕННАЯ ПЕРЕДАЧА) С МОТОРОМ

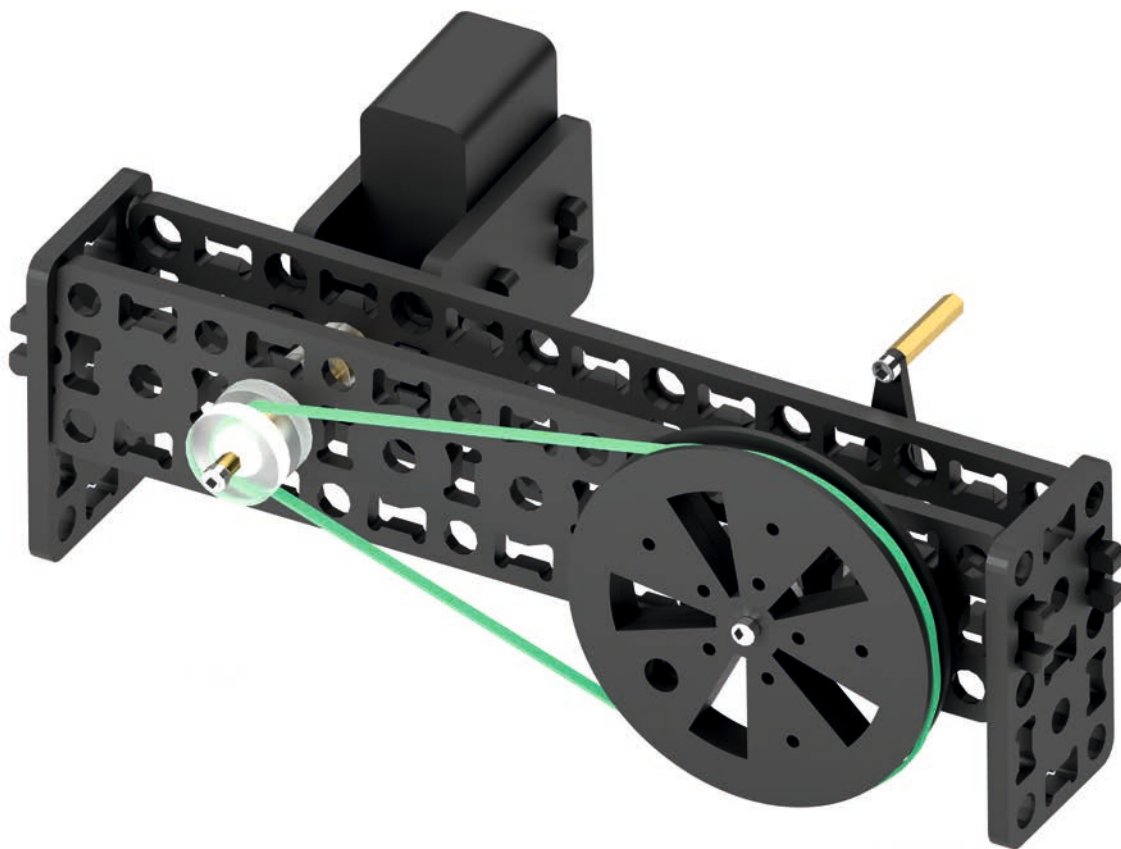

ИСПОЛЬЗУЕМЫЕ ДЕТАЛИ ДЛЯ СБОРКИ

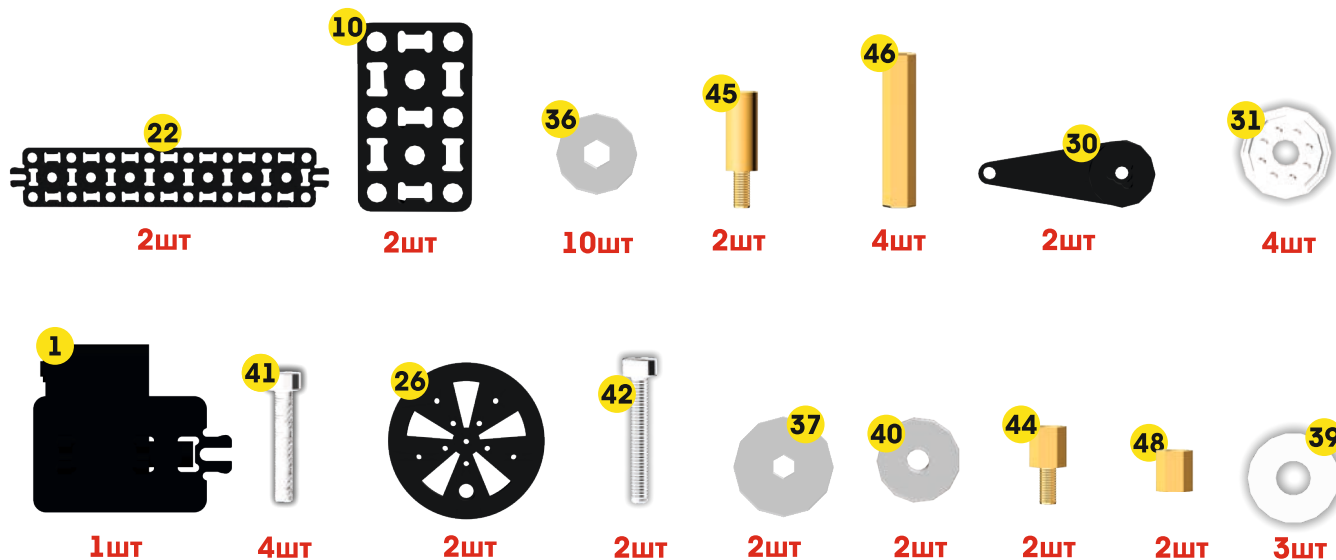

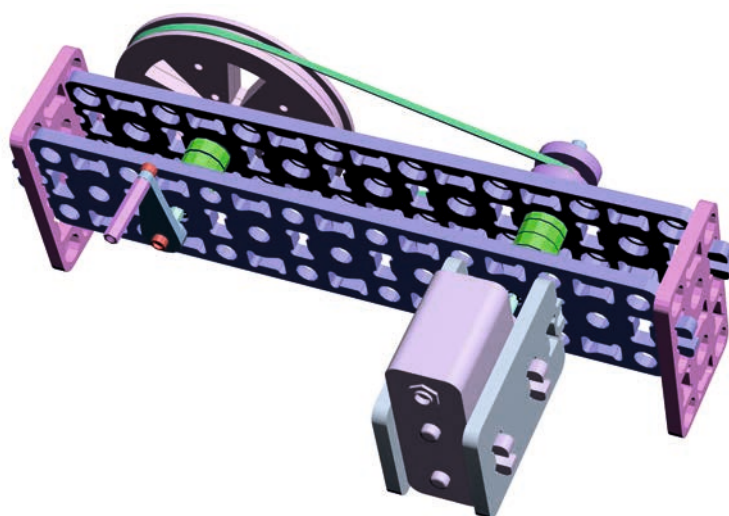
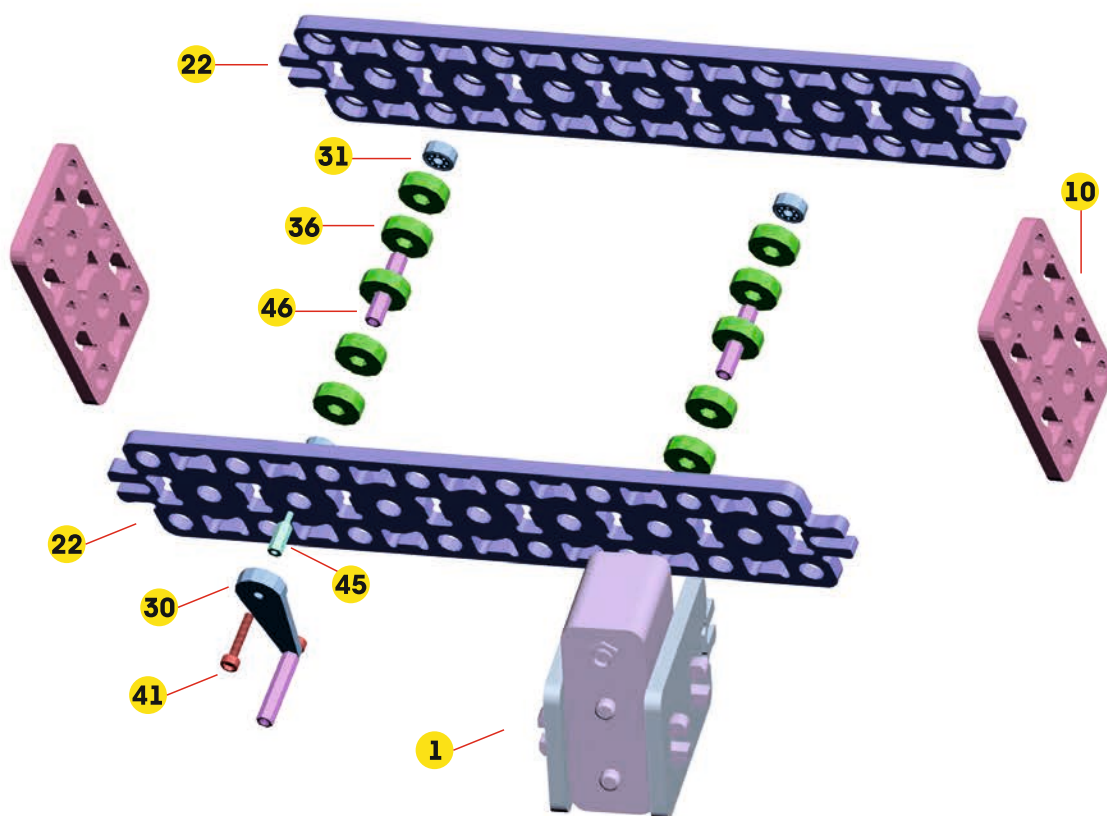
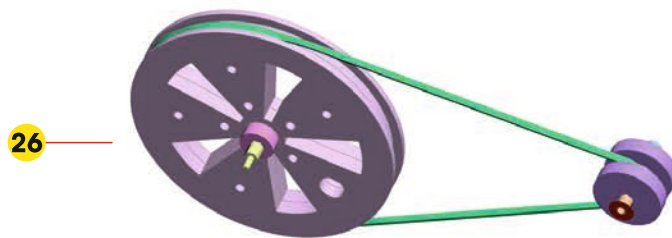

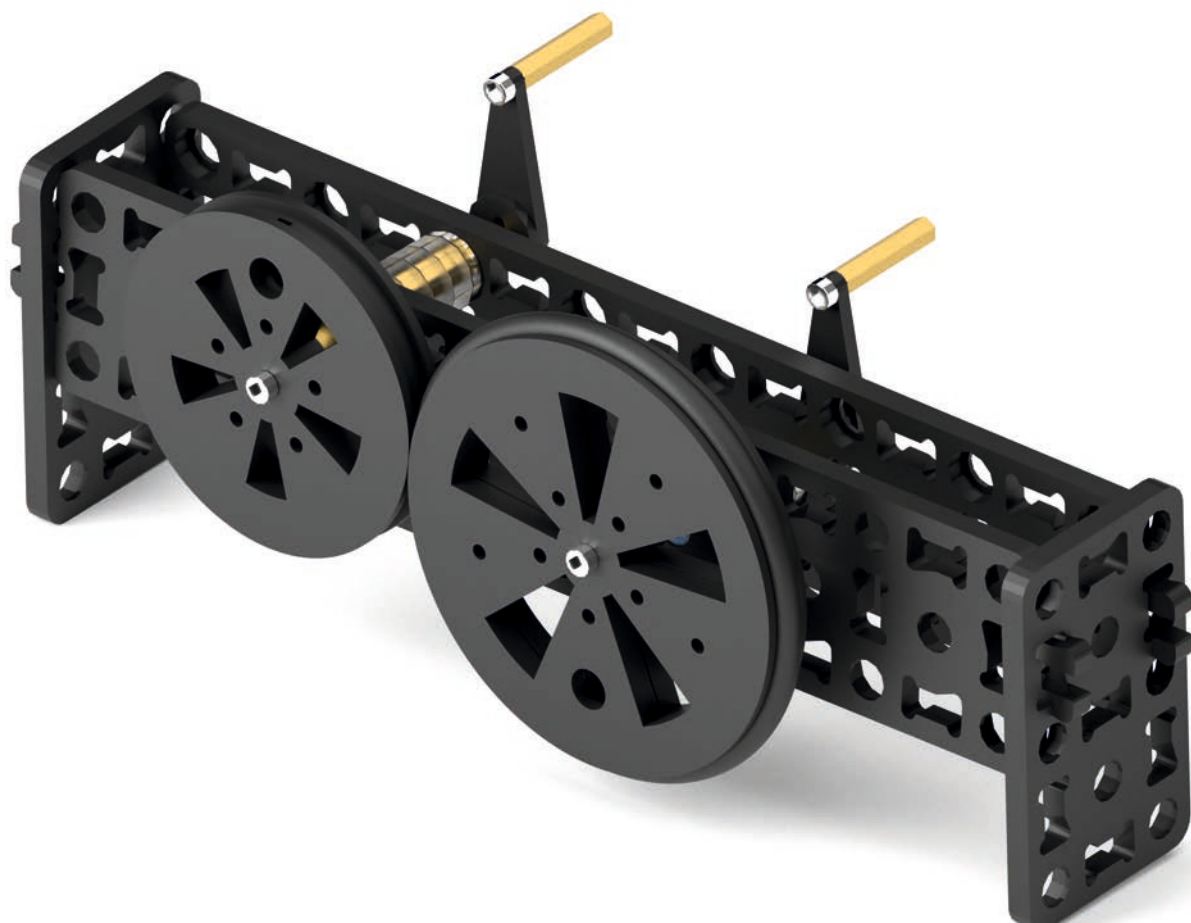

ИСПОЛЬЗУЕМЫЕ ДЕТАЛИ ДЛЯ СБОРКИ

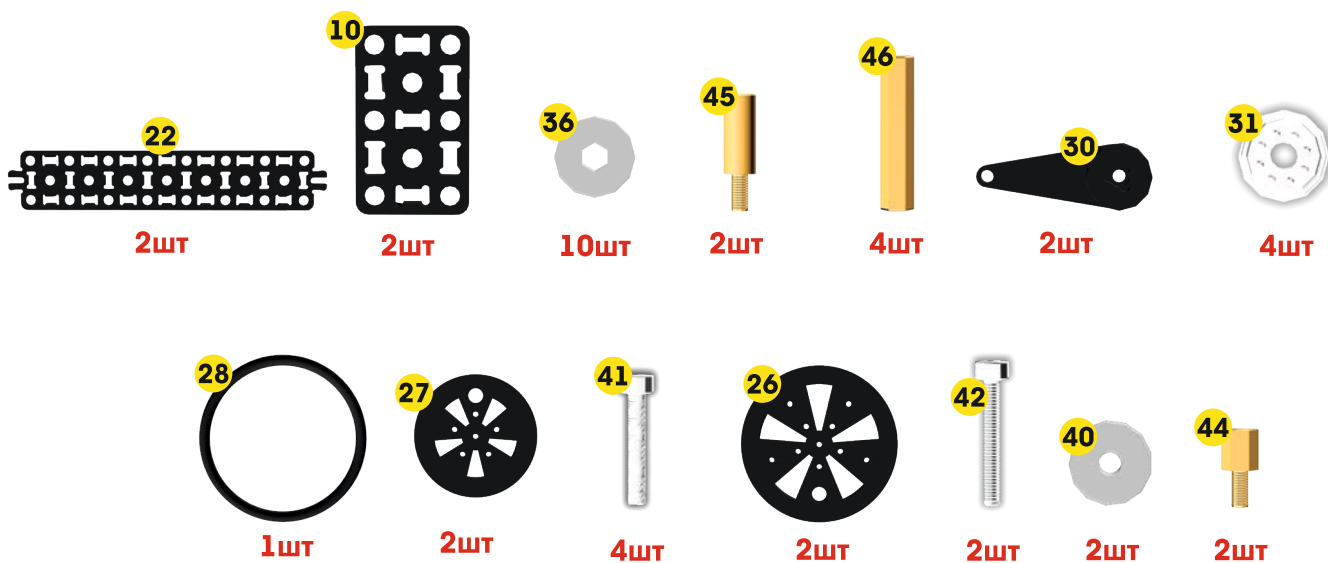

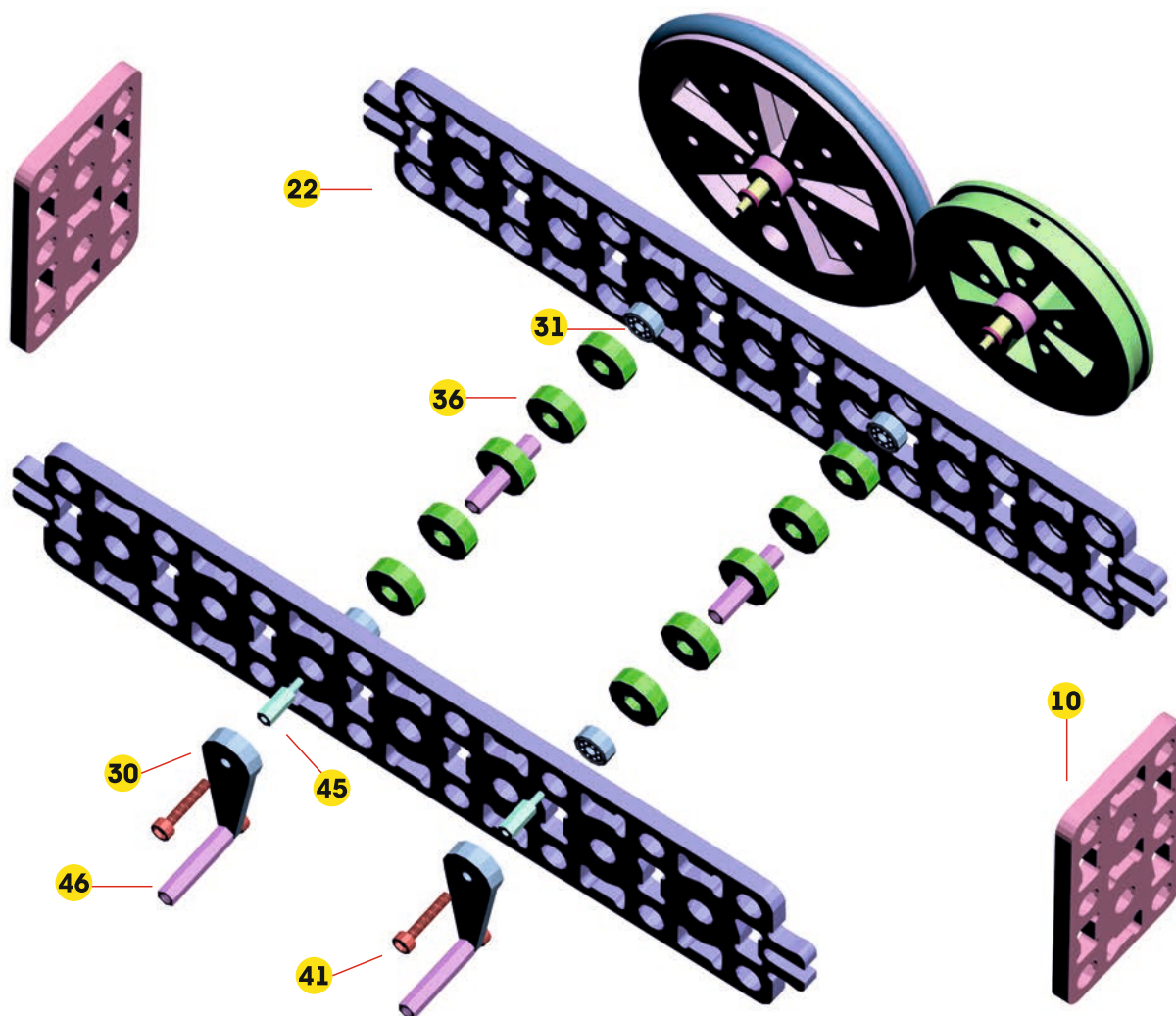

БОРКА ПРИВОДНЫХ КОЛЕС:

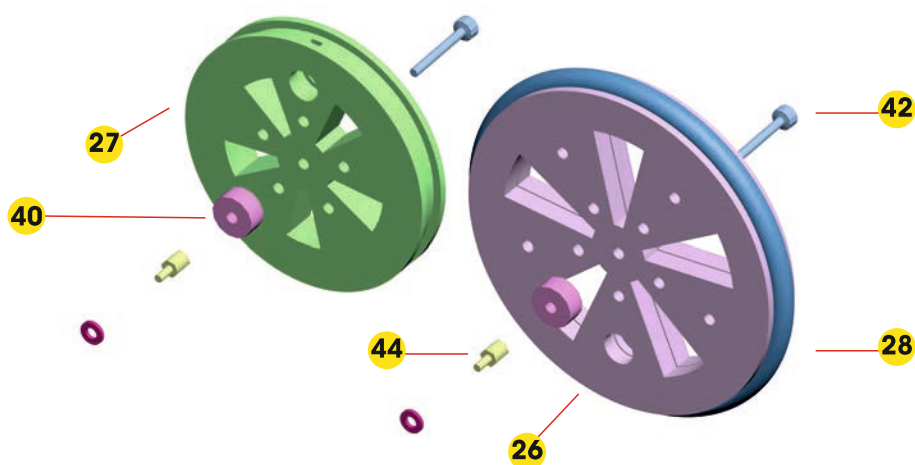

МОДЕЛЬ №85:

ФРИКЦИОННАЯ ПЕРЕДАЧА С МОТОРОМ

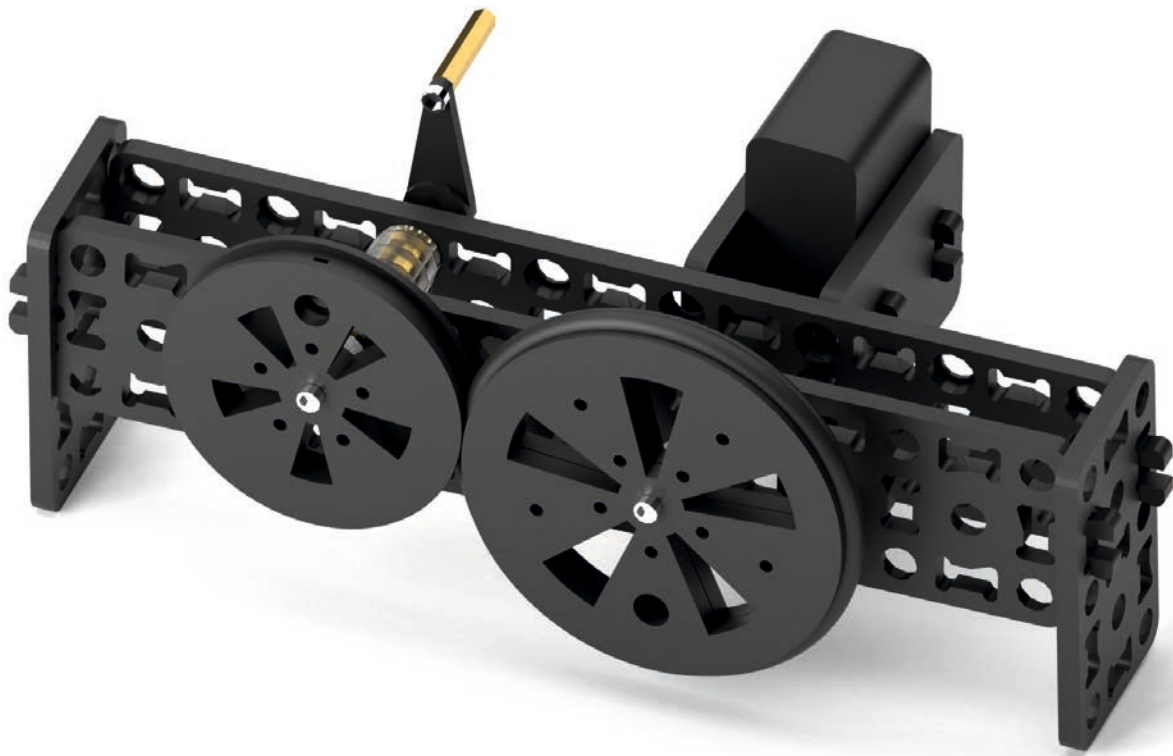

ИСПОЛЬЗУЕМЫЕ ДЕТАЛИ ДЛЯ СБОРКИ

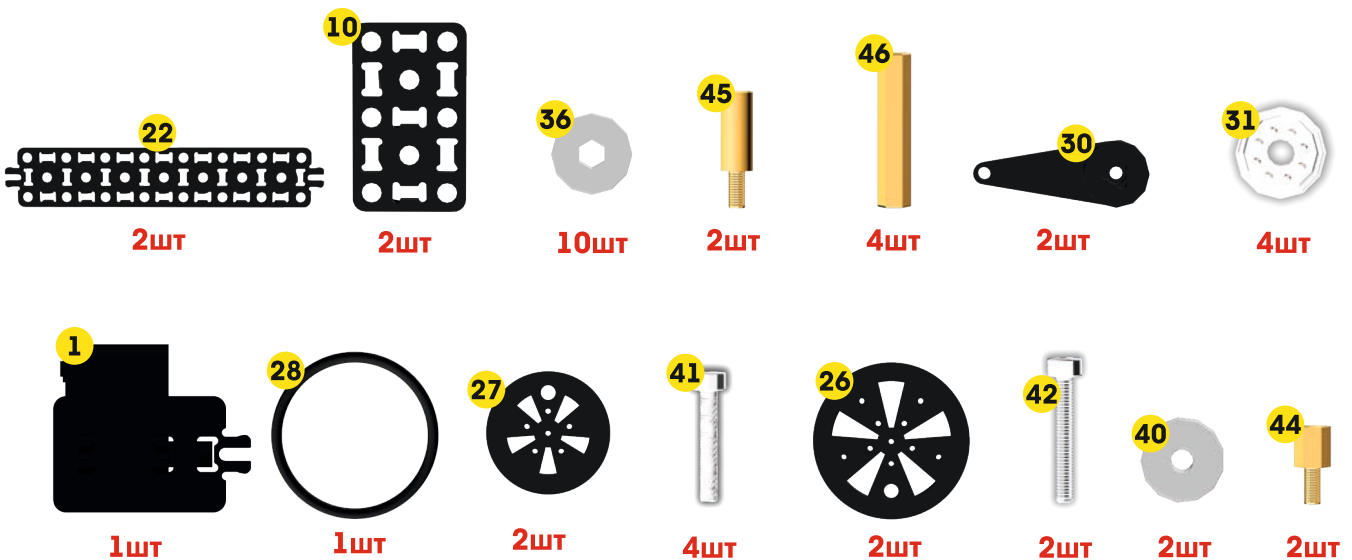

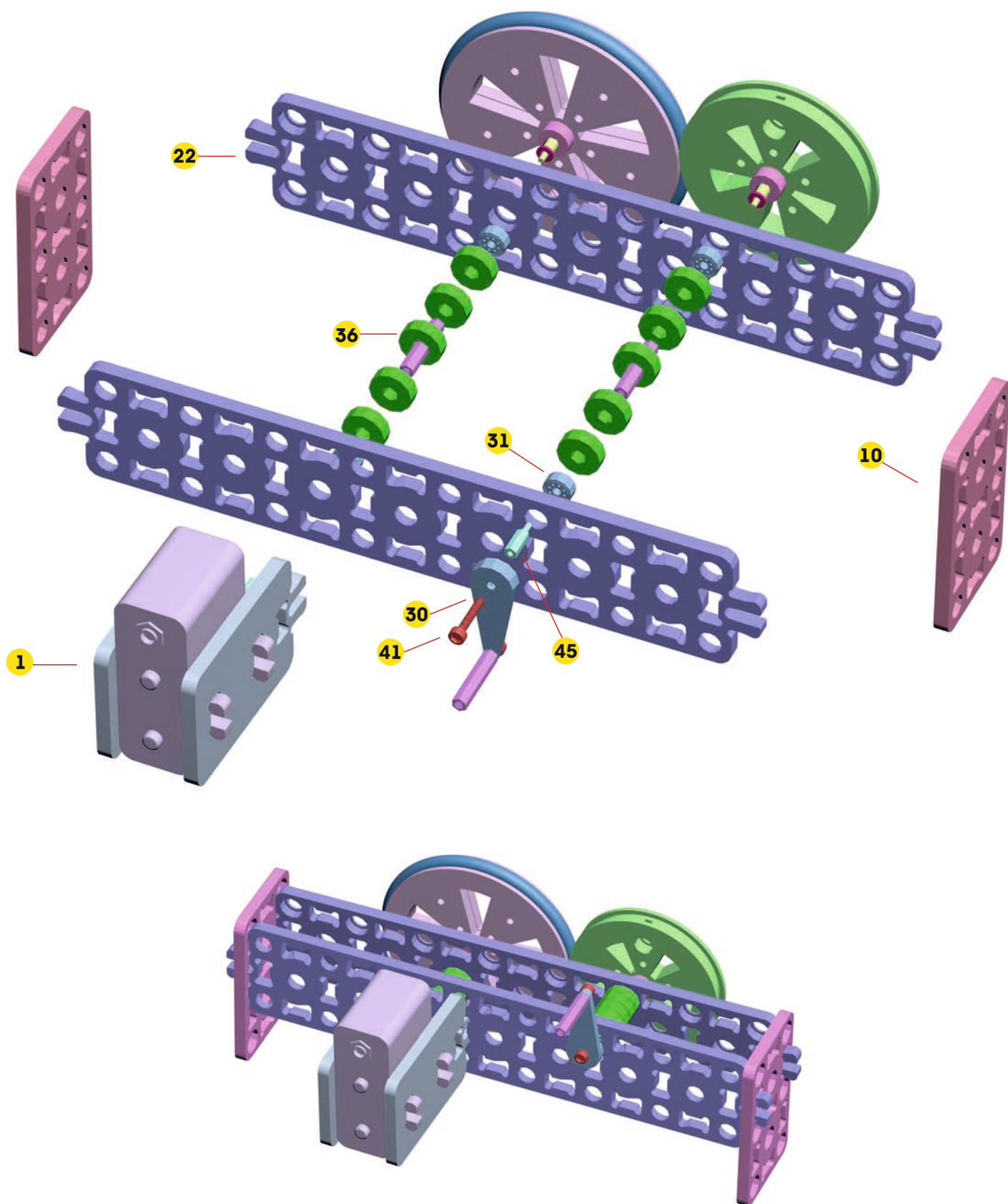

МОДЕЛЬ №9:

ПЛАНЕТАРНЫЙ РЕДУКТОР

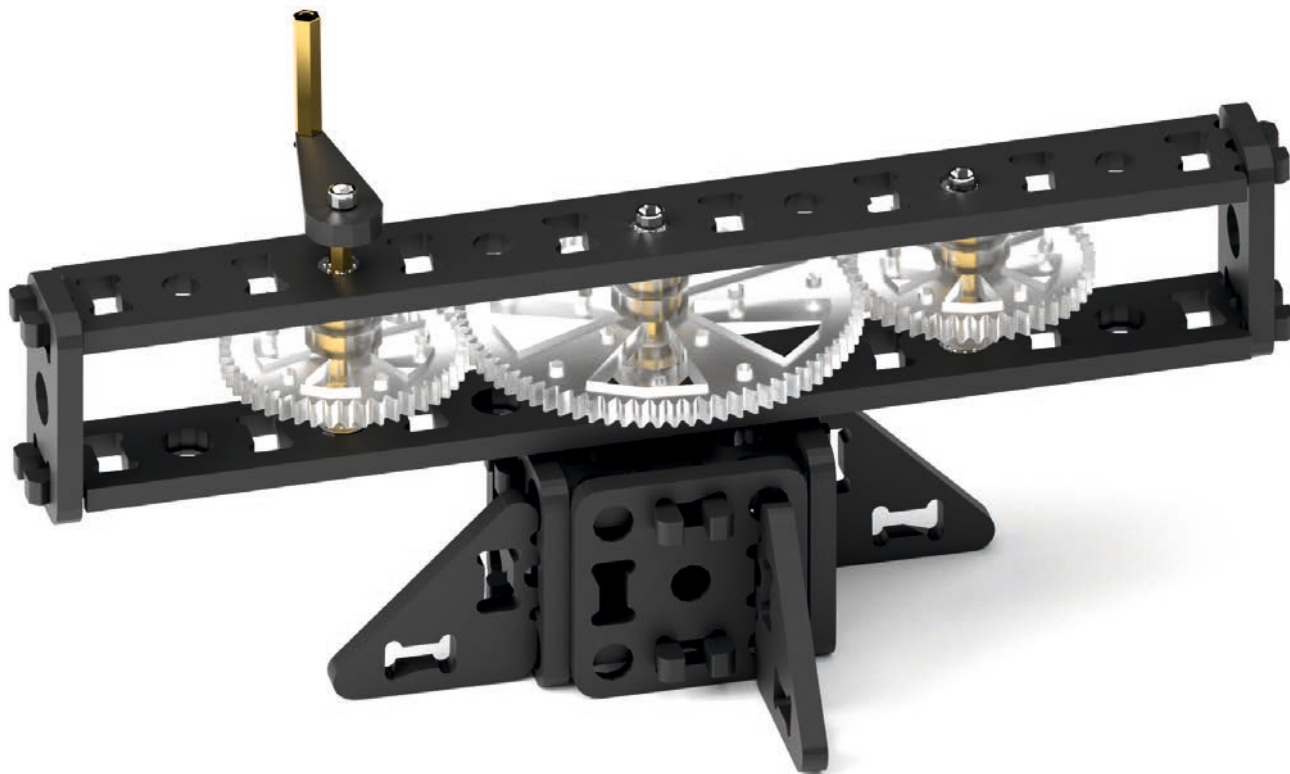

ИСПОЛЬЗУЕМЫЕ ДЕТАЛИ ДЛЯ СБОРКИ

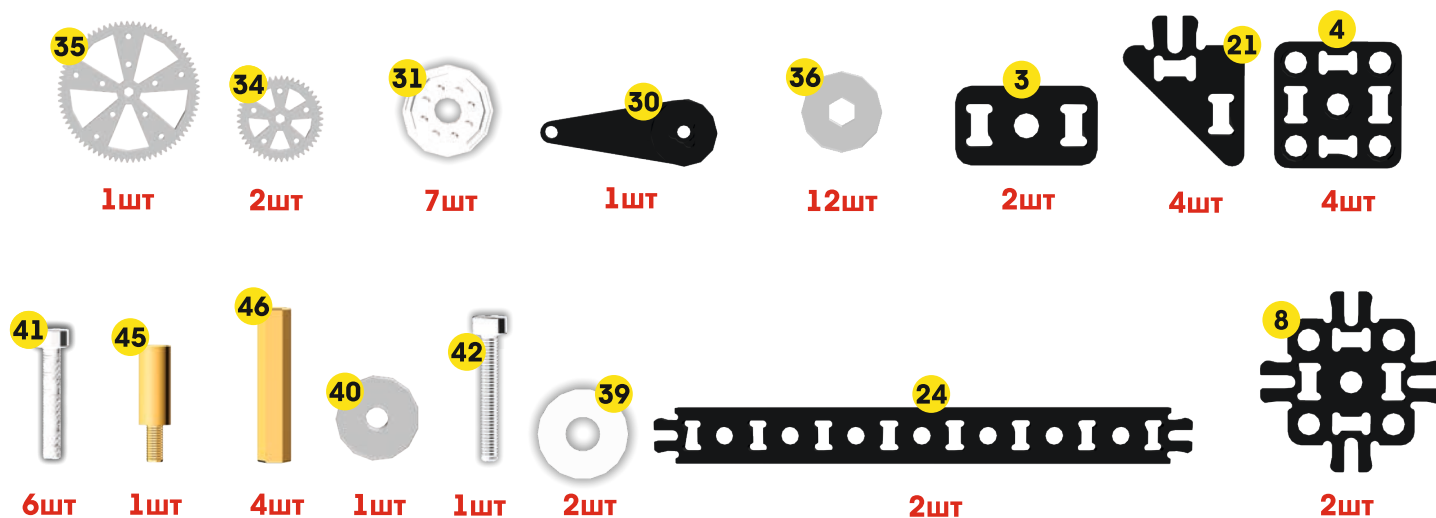

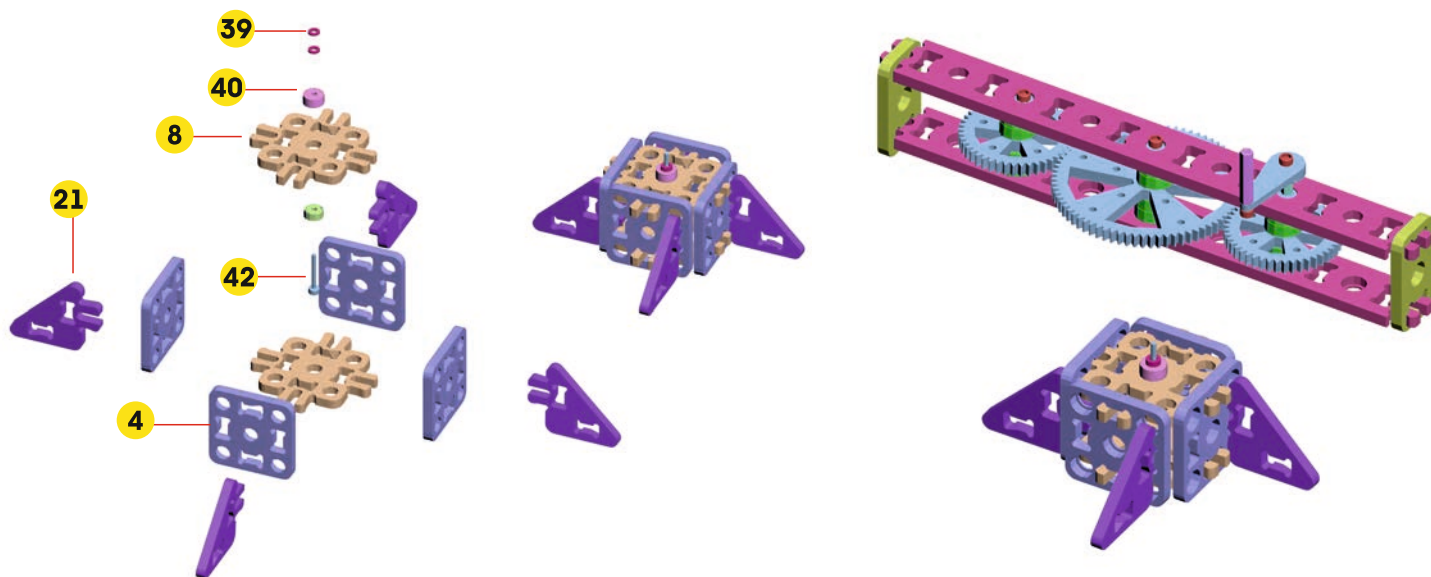
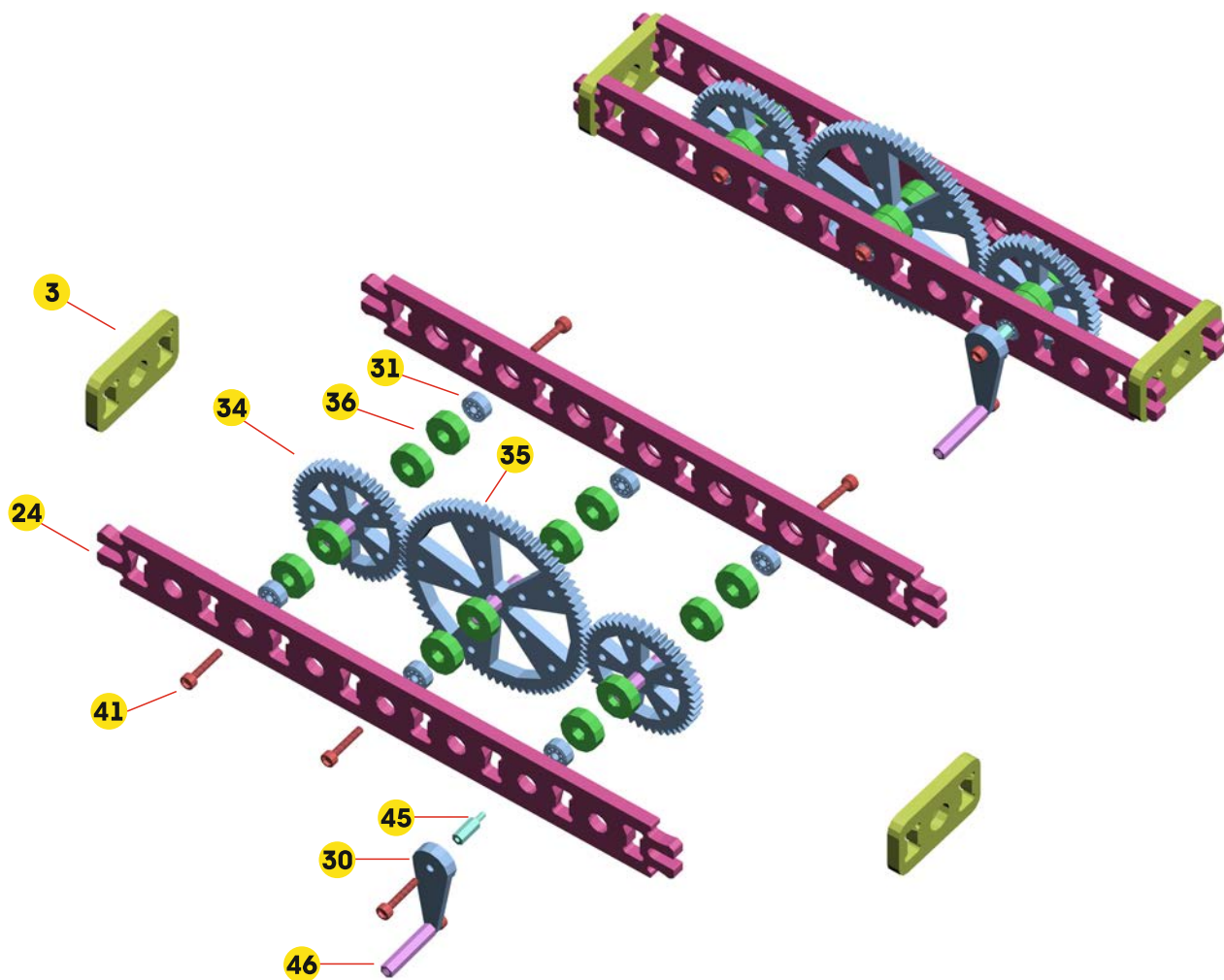

МОДЕЛЬ №10:

КОЛЕСНАЯ ПЛАТФОРМА

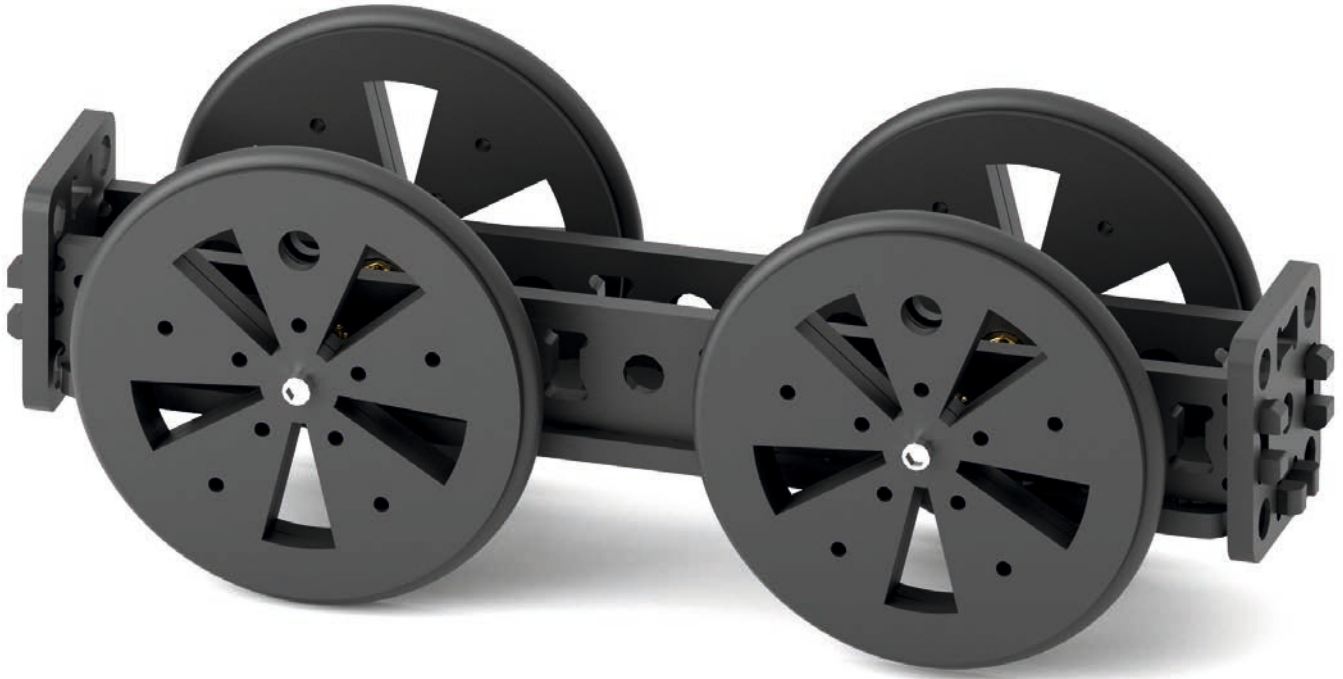

ИСПОЛЬЗУЕМЫЕ ДЕТАЛИ ДЛЯ СБОРКИ

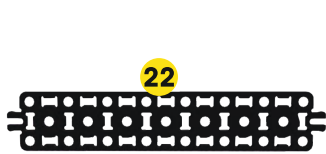

1шт



8шт



4шт



4шт



4шт



2шт



4шт



4шт



4шт



2шт

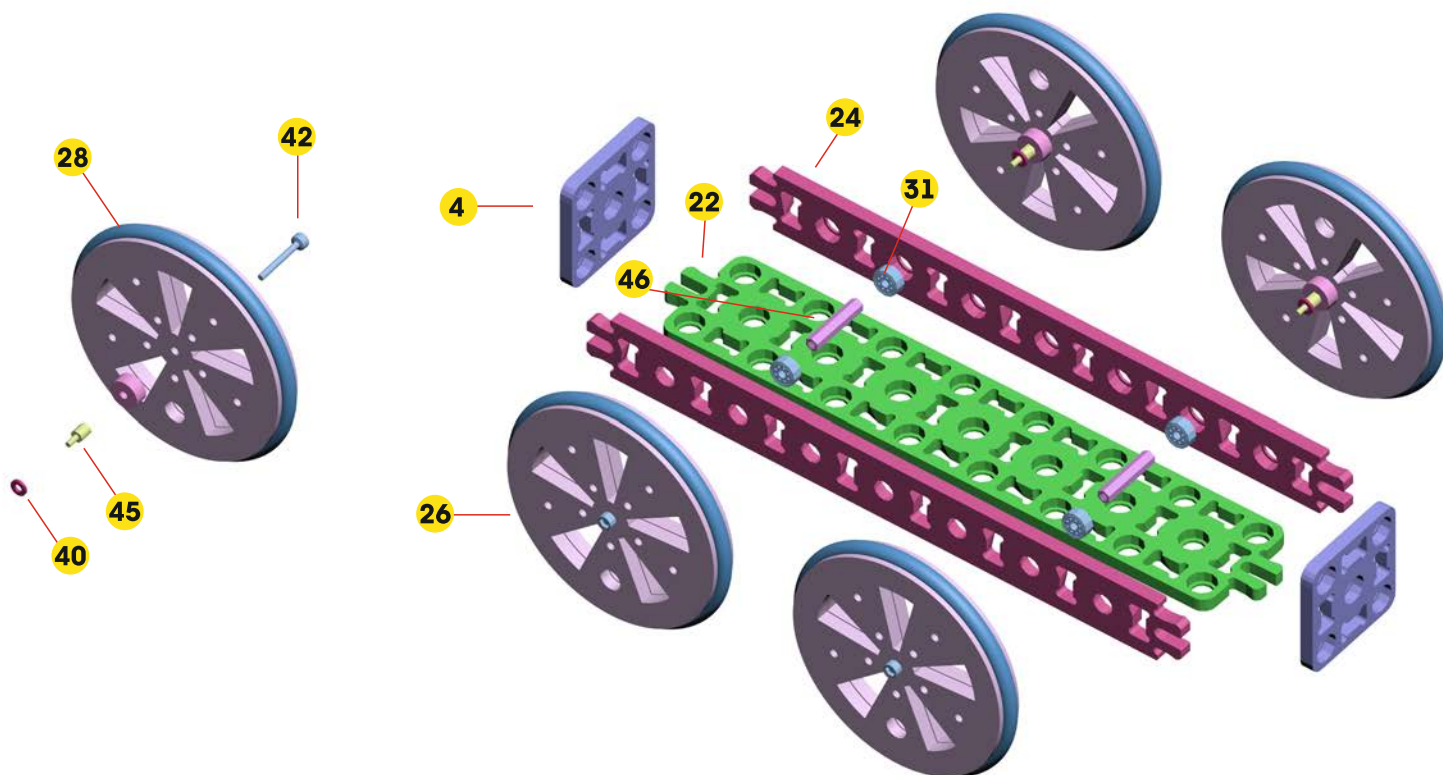

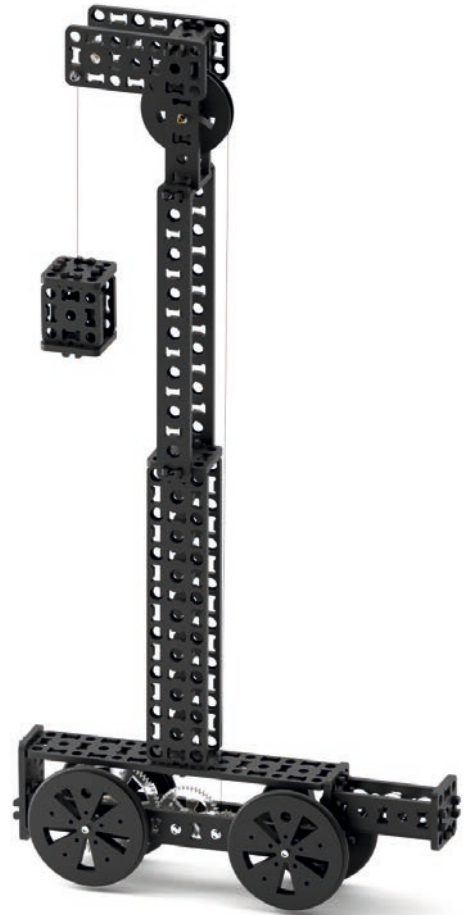
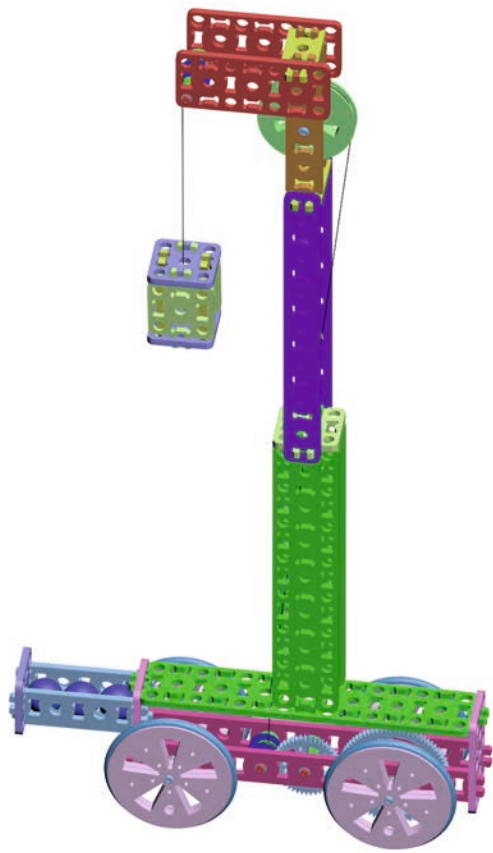

ИСПОЛЬЗУЕМЫЕ ДЕТАЛИ ДЛЯ СБОРКИ

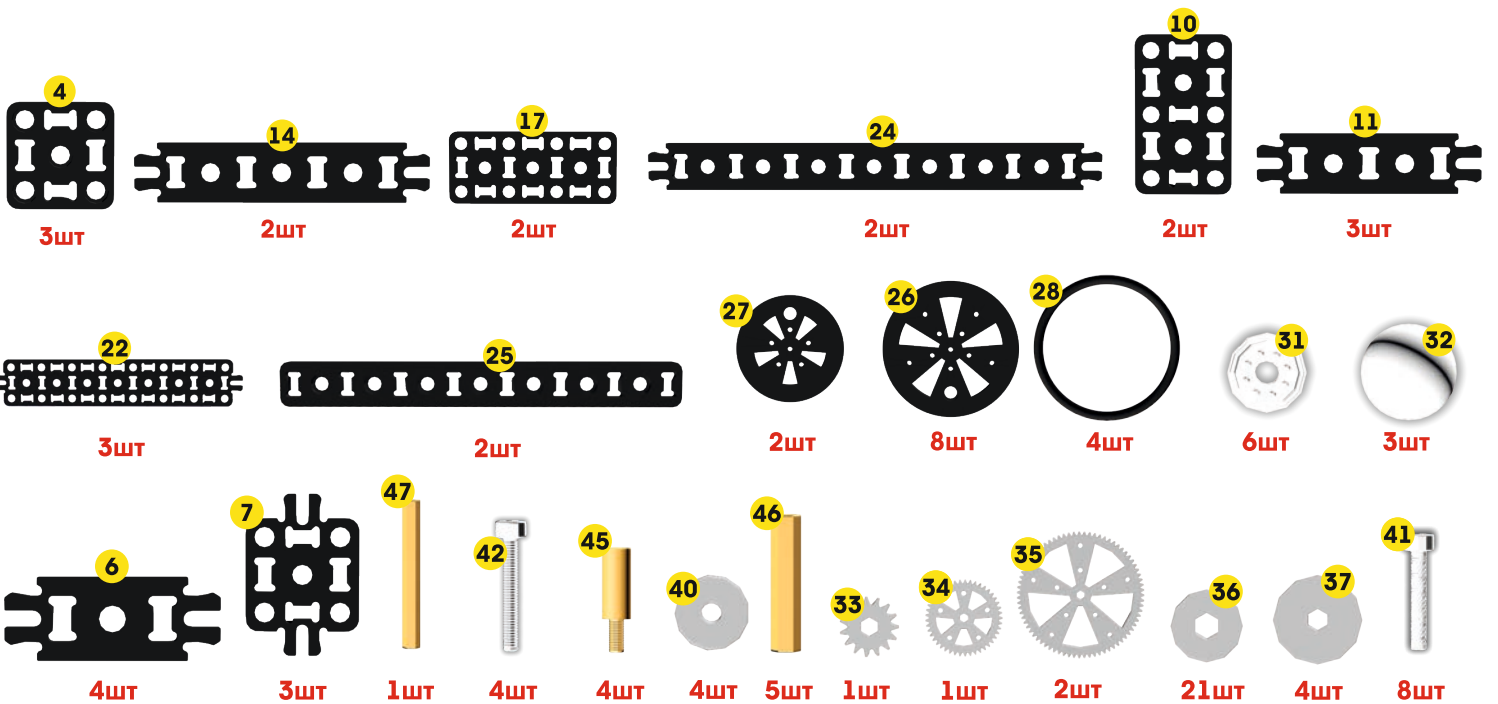

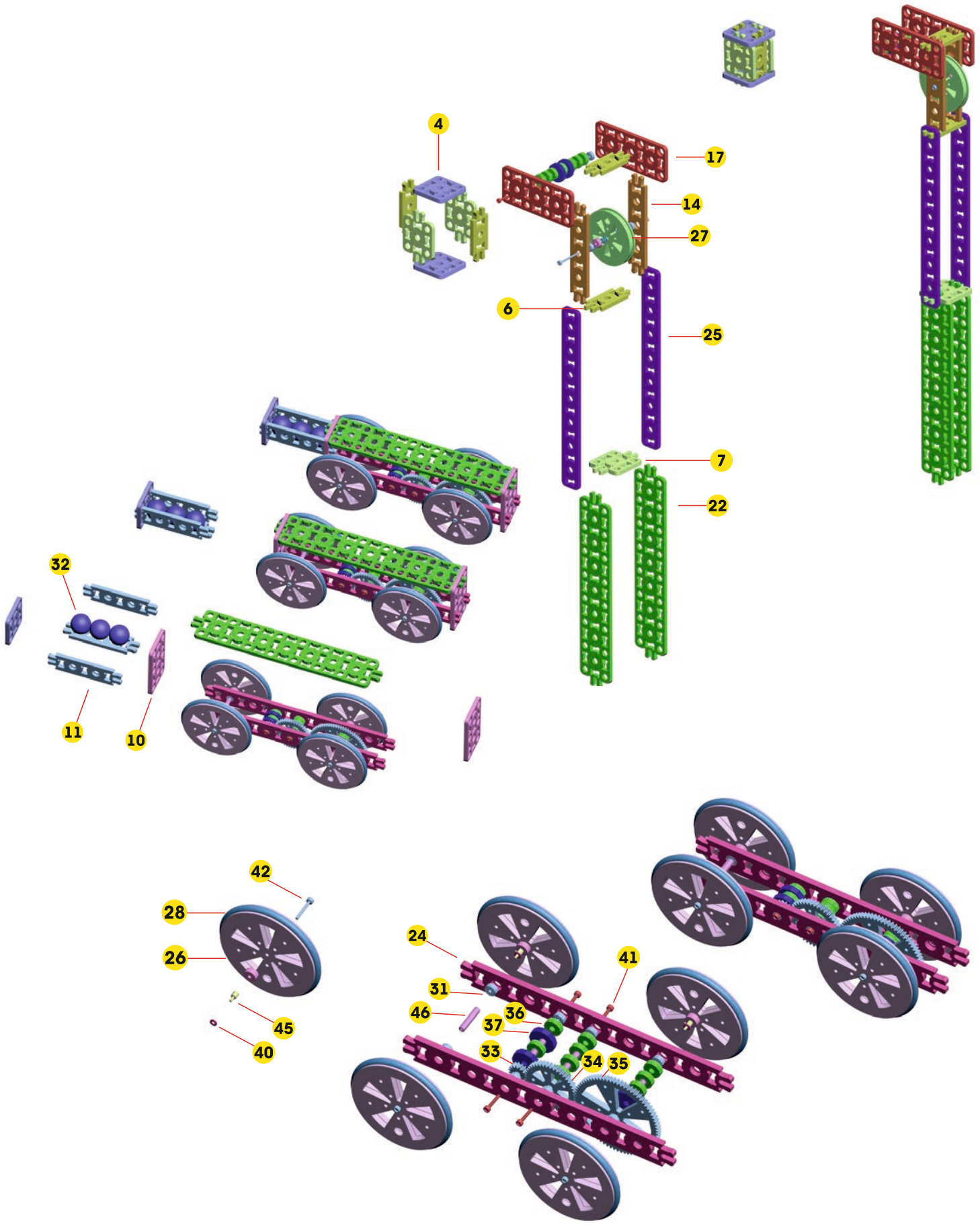

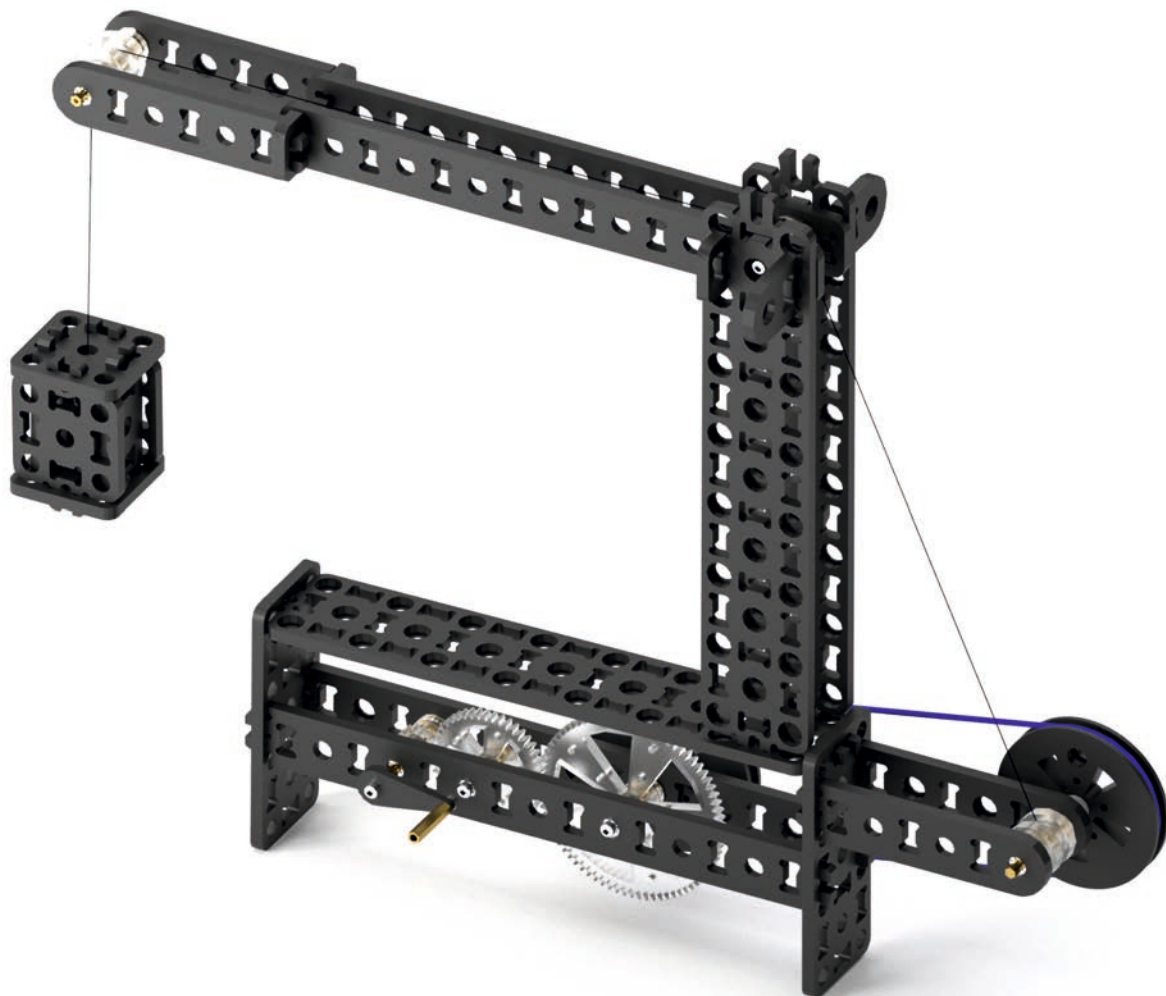

ИСПОЛЬЗУЕМЫЕ ДЕТАЛИ ДЛЯ СБОРКИ

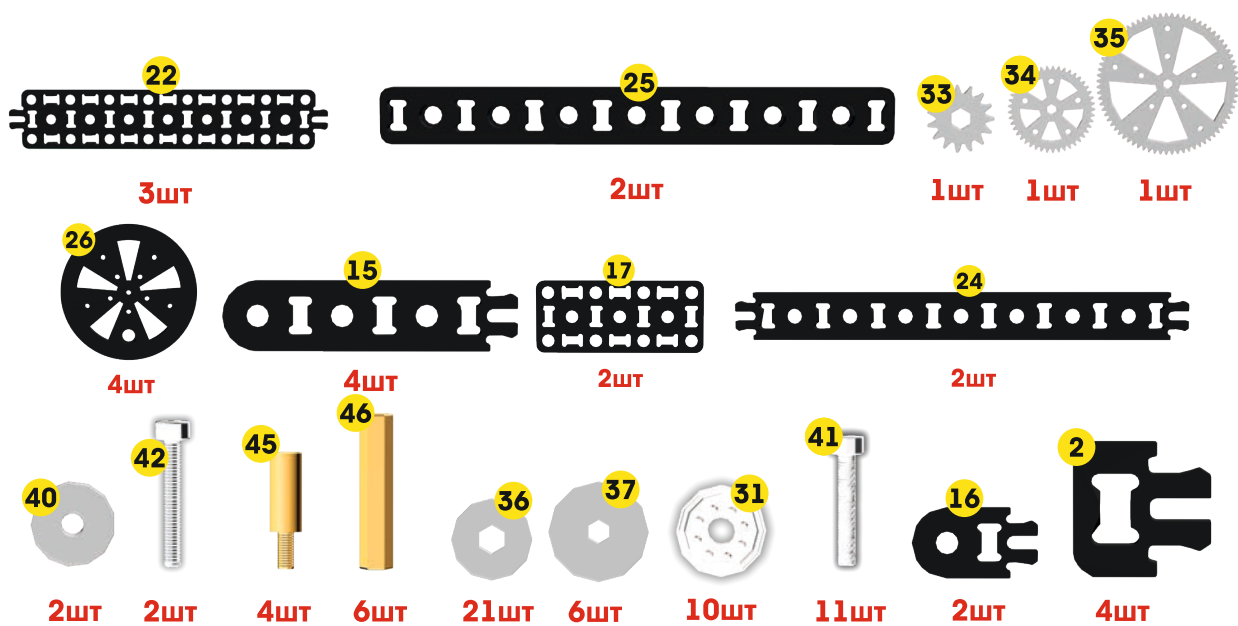

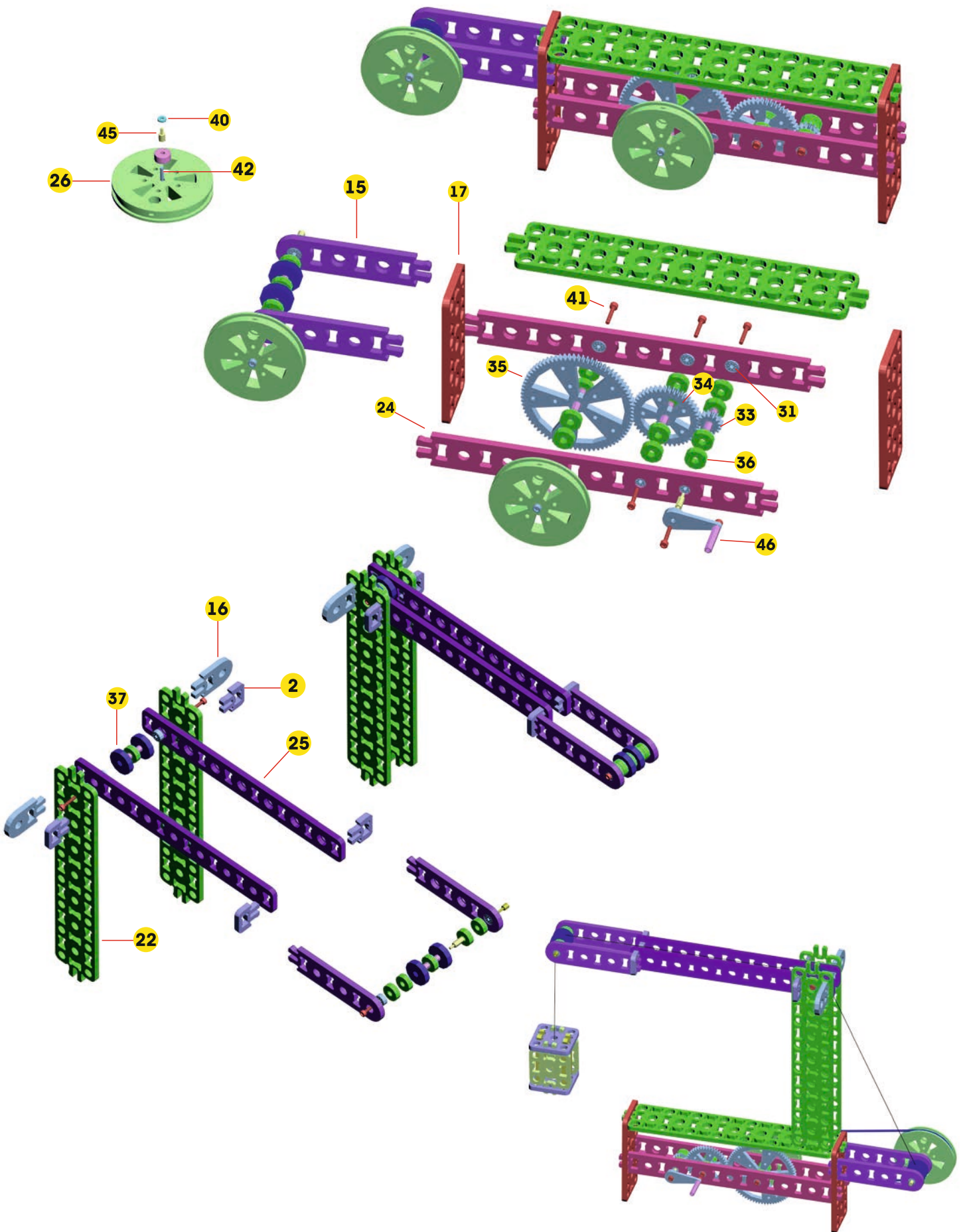

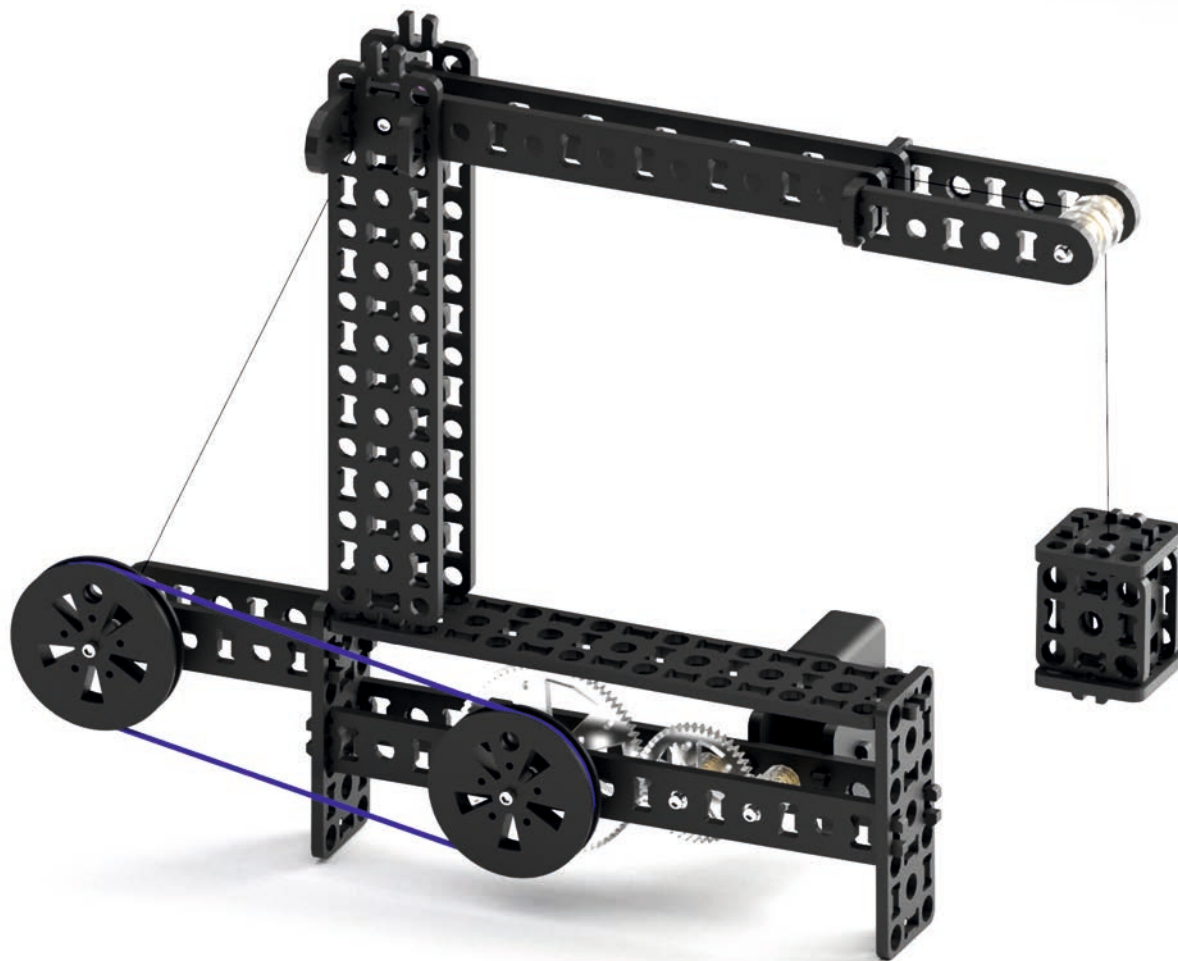

ИСПОЛЬЗУЕМЫЕ ДЕТАЛИ ДЛЯ СБОРКИ

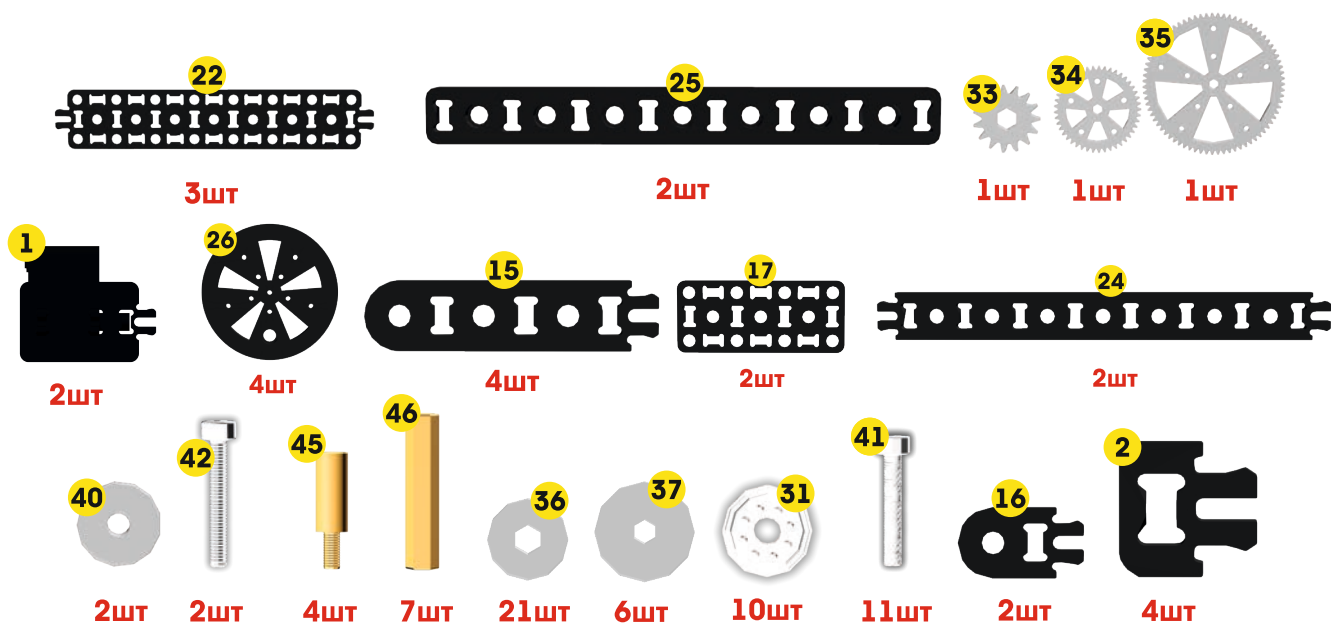

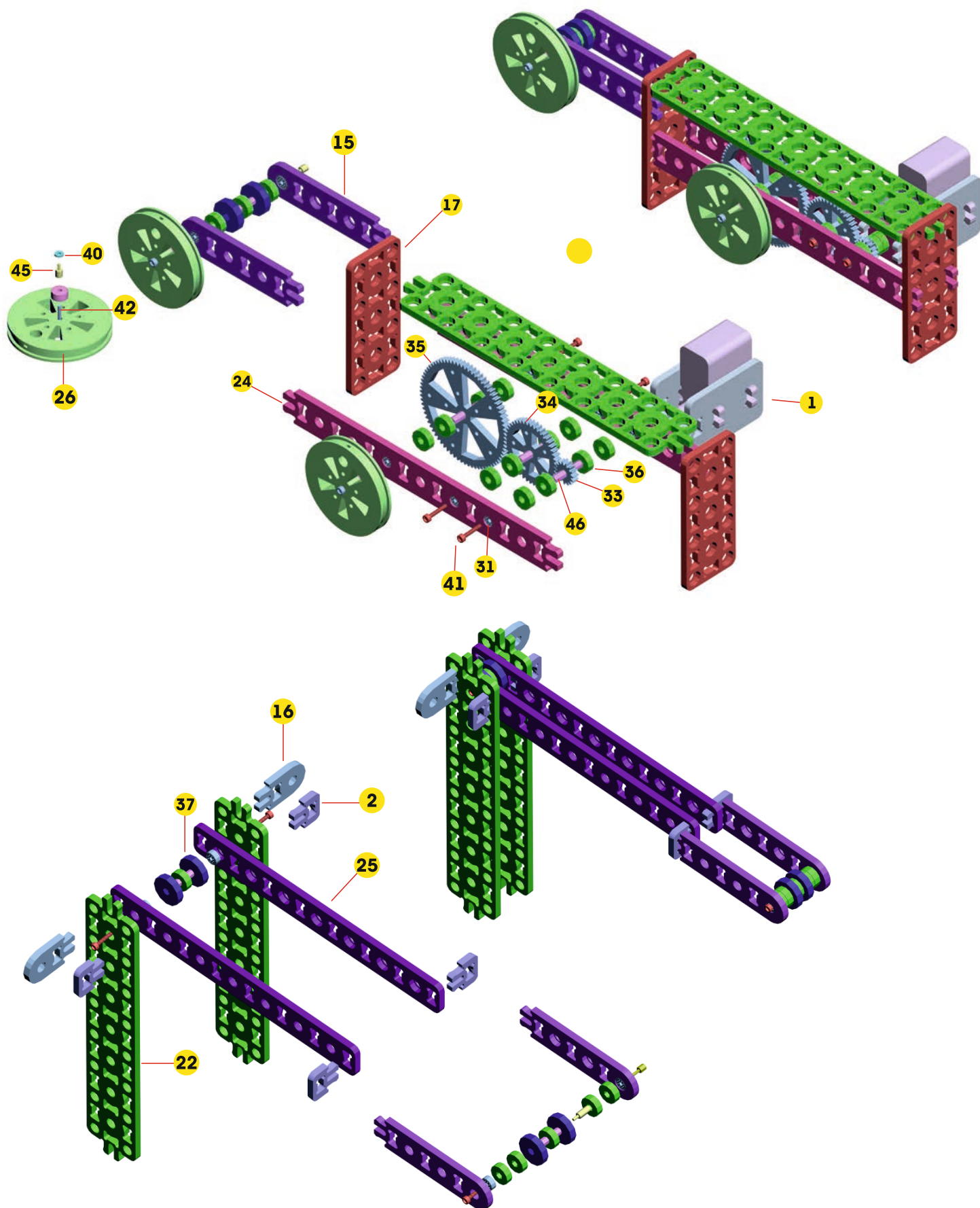



ИСПОЛЬЗУЕМЫЕ ДЕТАЛИ ДЛЯ СБОРКИ

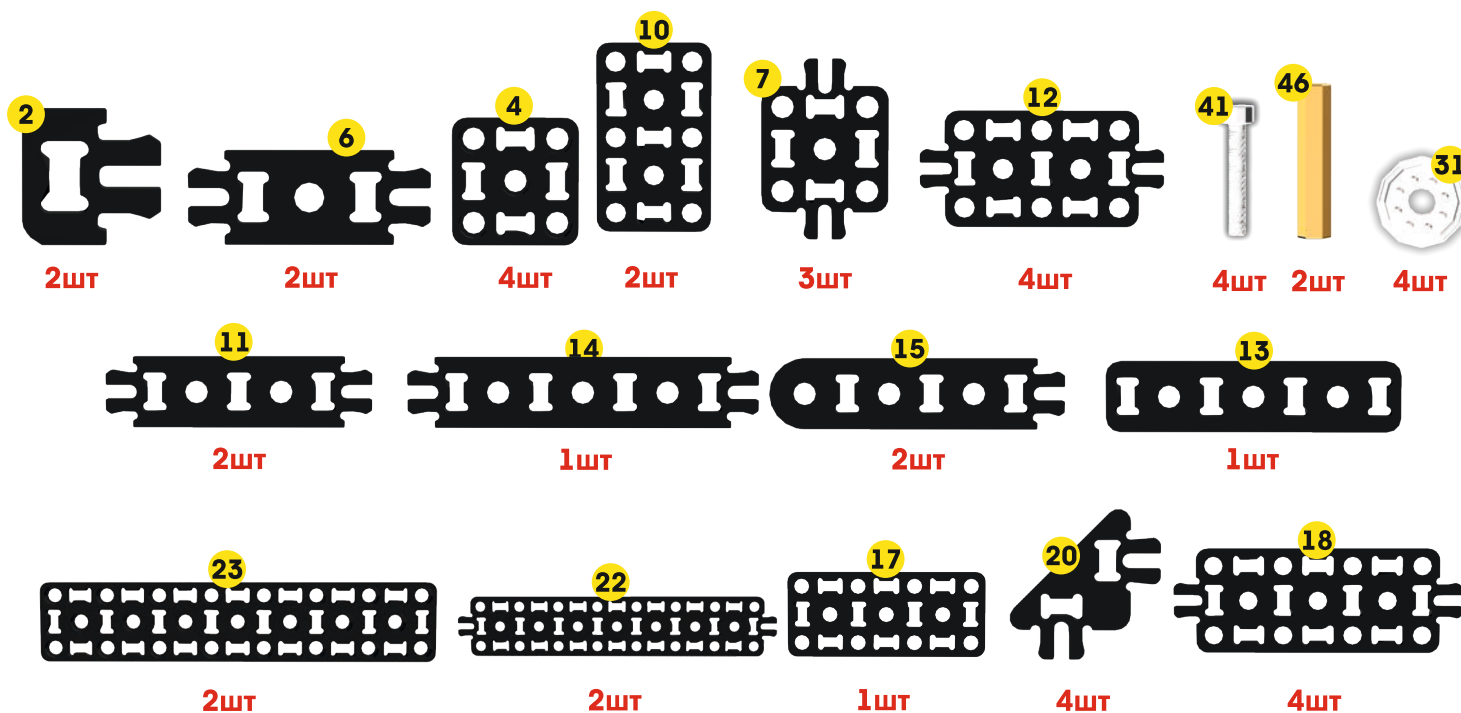

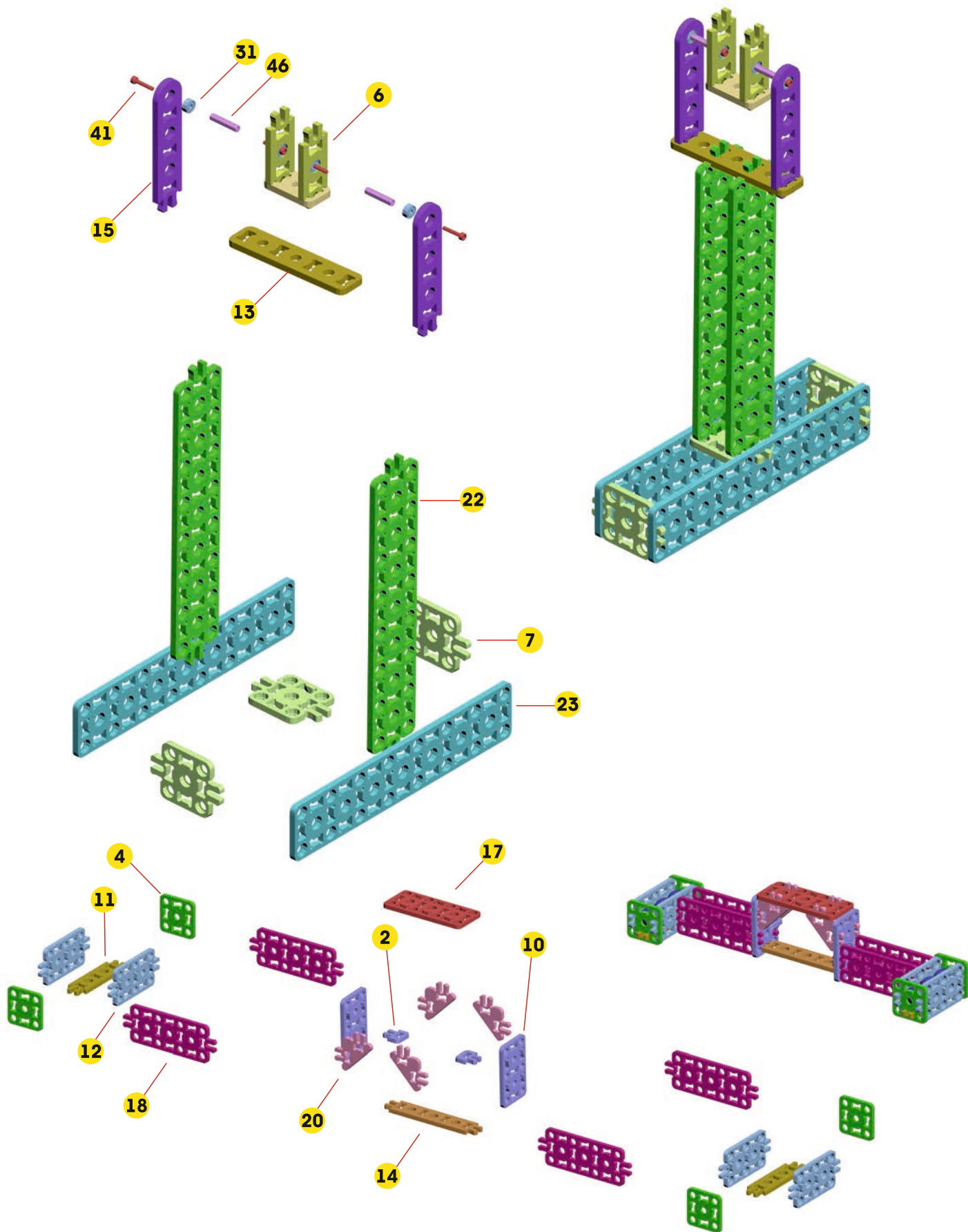

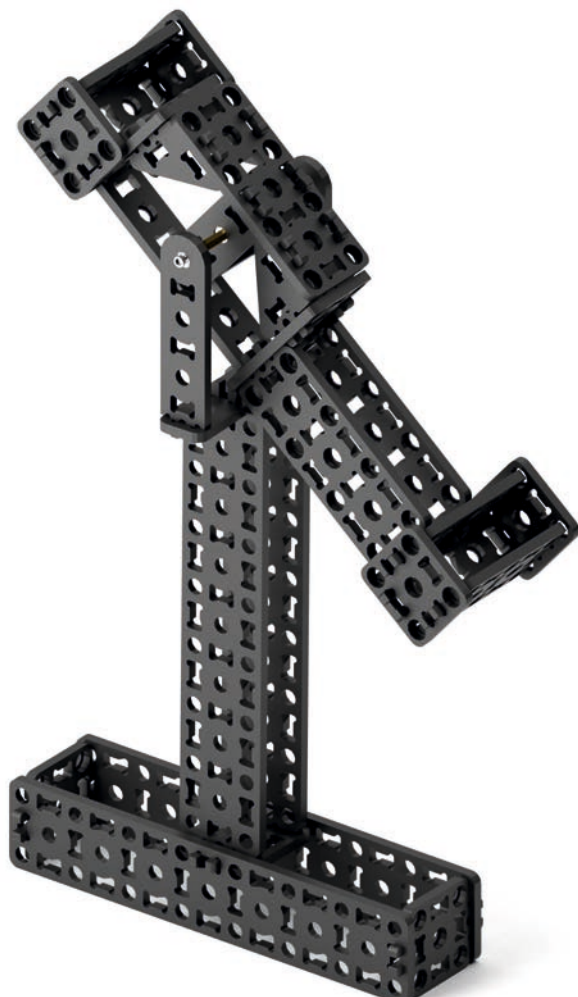

ИСПОЛЬЗУЕМЫЕ ДЕТАЛИ ДЛЯ СБОРКИ

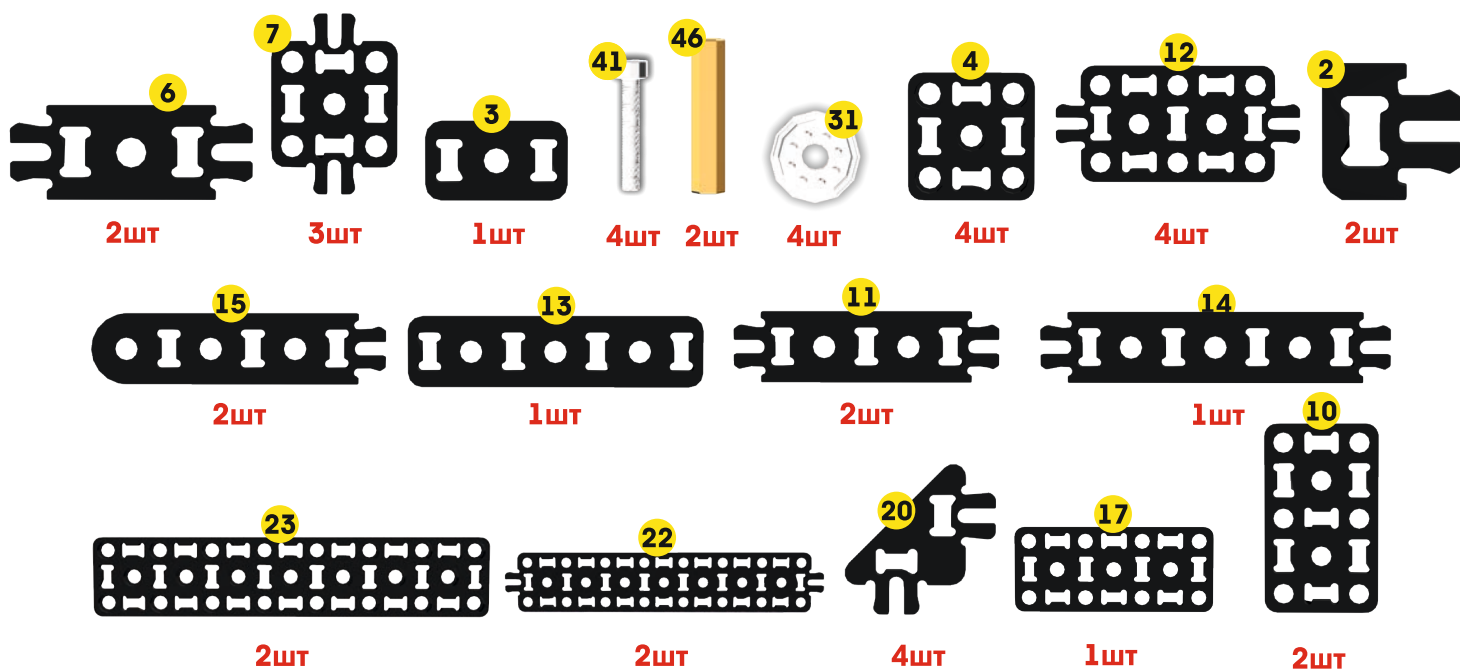

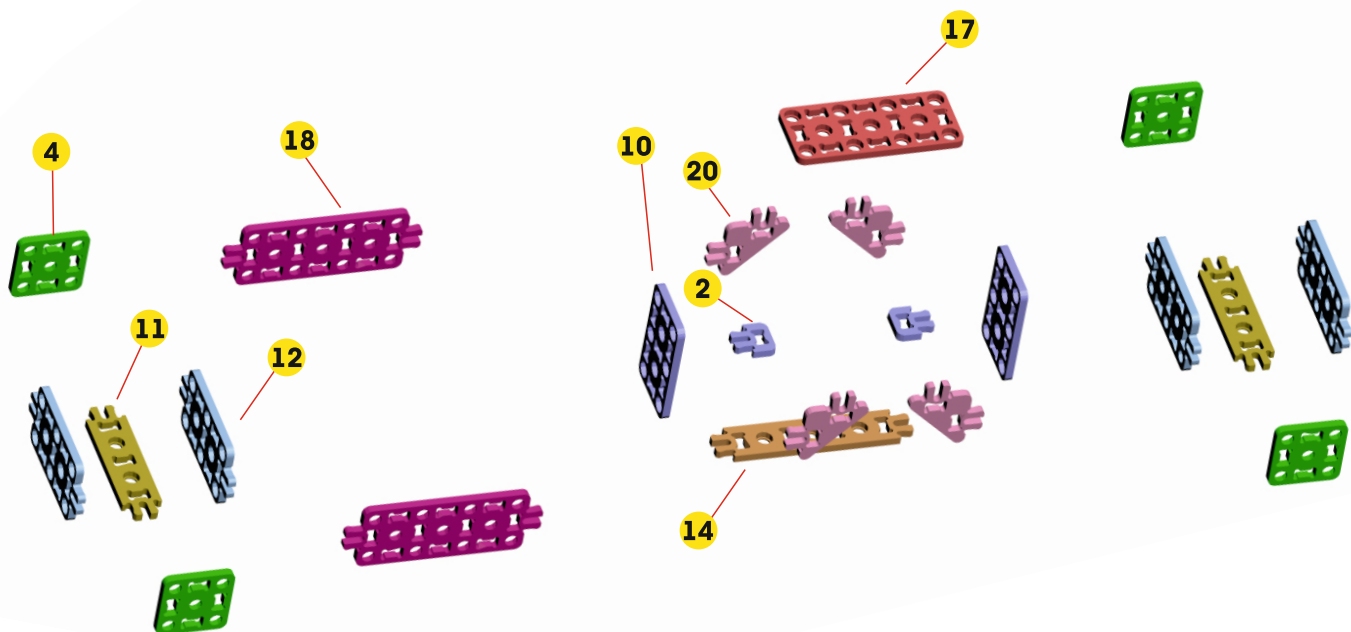
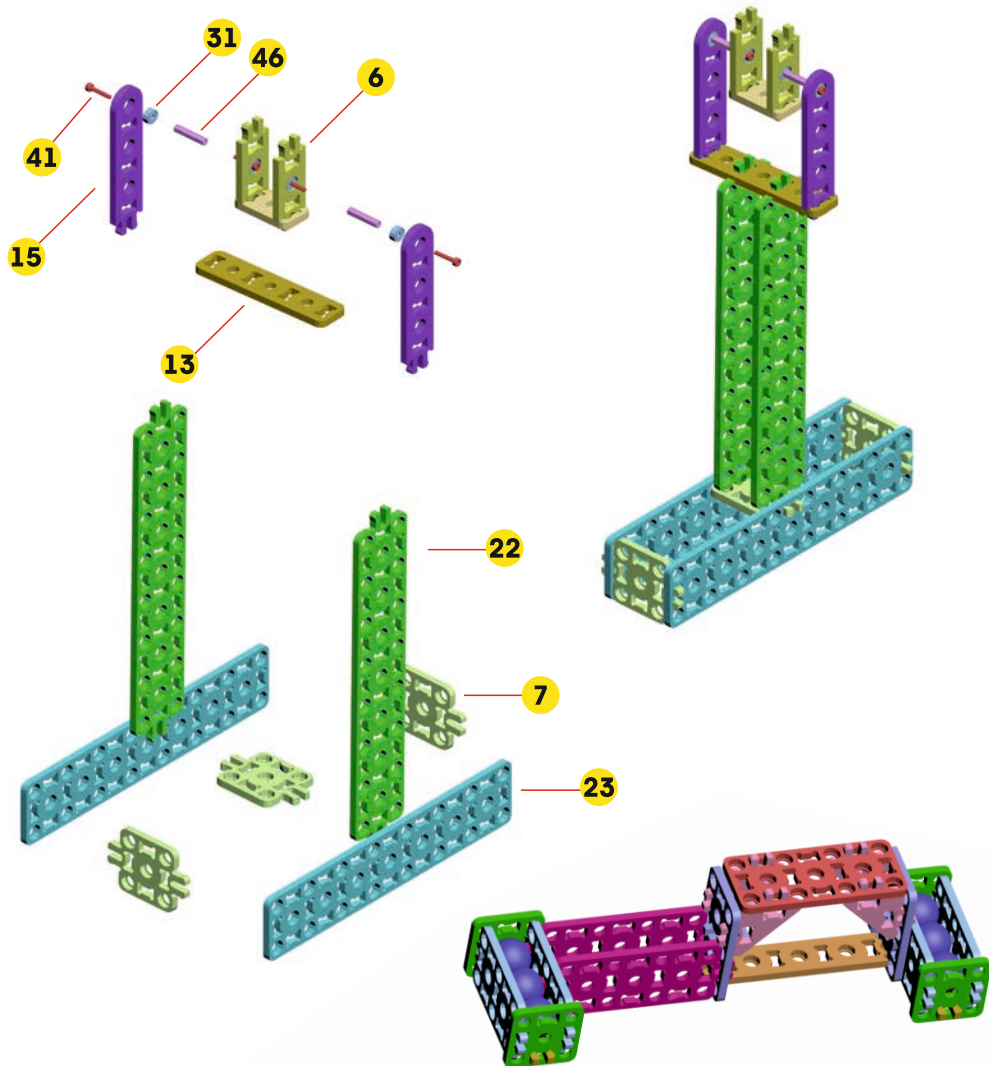

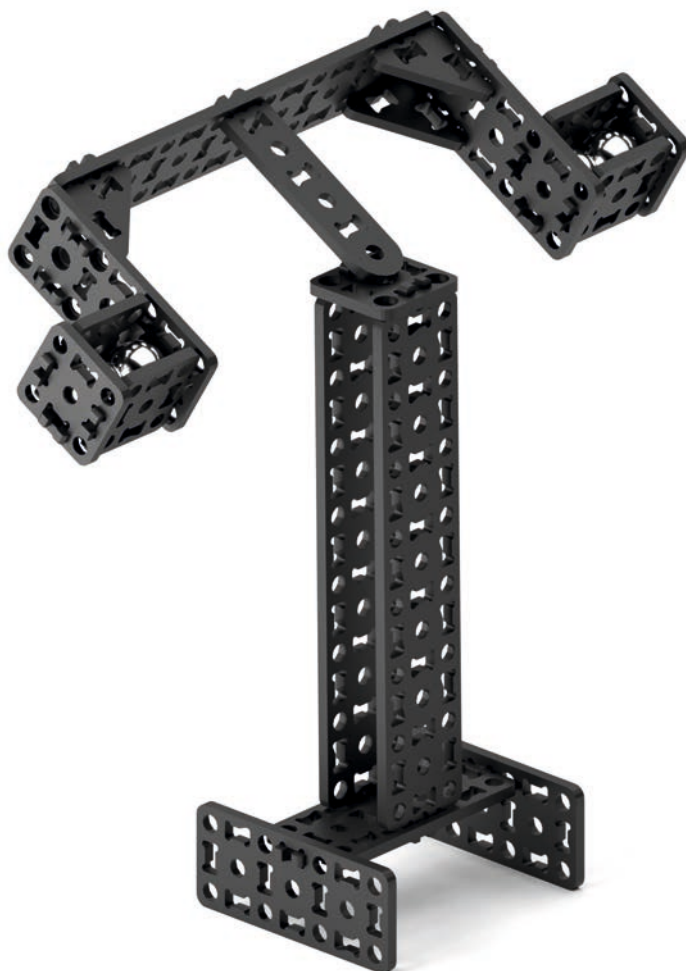

ИСПОЛЬЗУЕМЫЕ ДЕТАЛИ ДЛЯ СБОРКИ

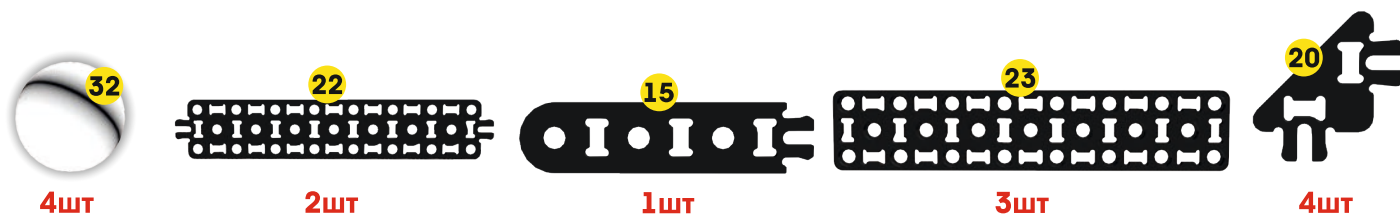
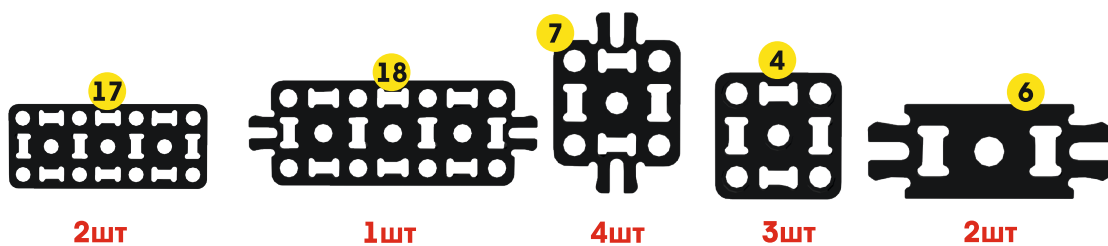

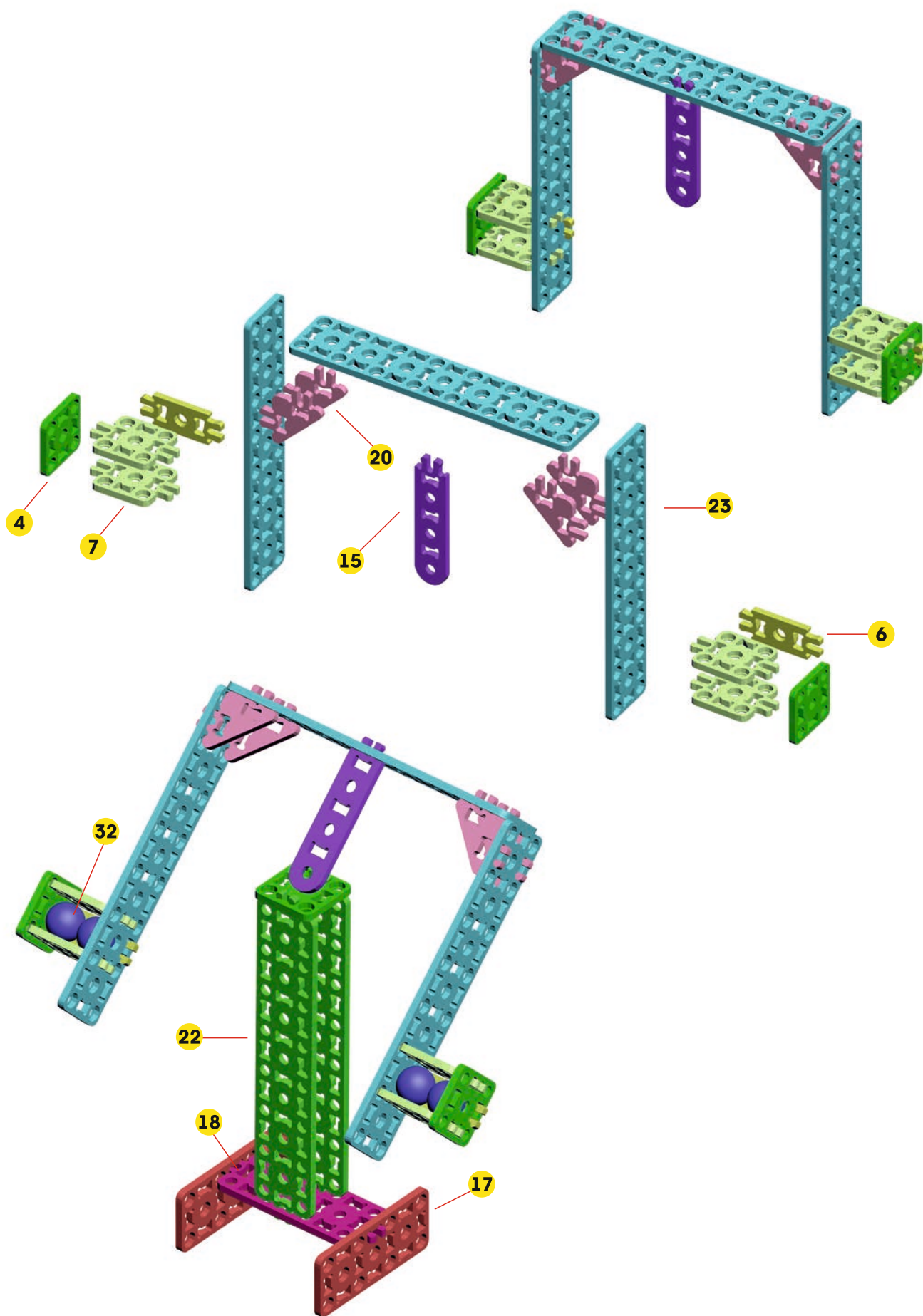

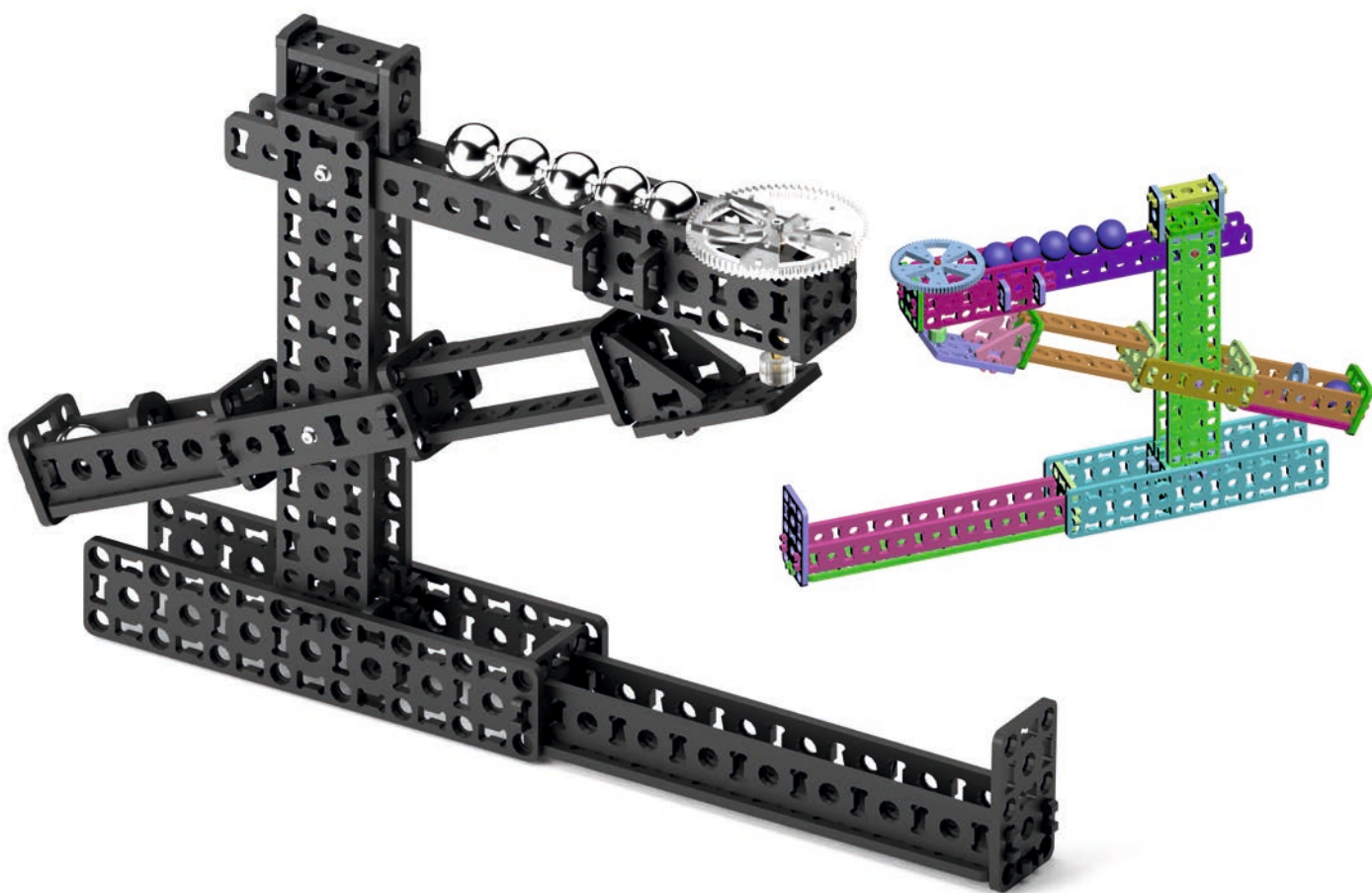

ИСПОЛЬЗУЕМЫЕ ДЕТАЛИ ДЛЯ СБОРКИ

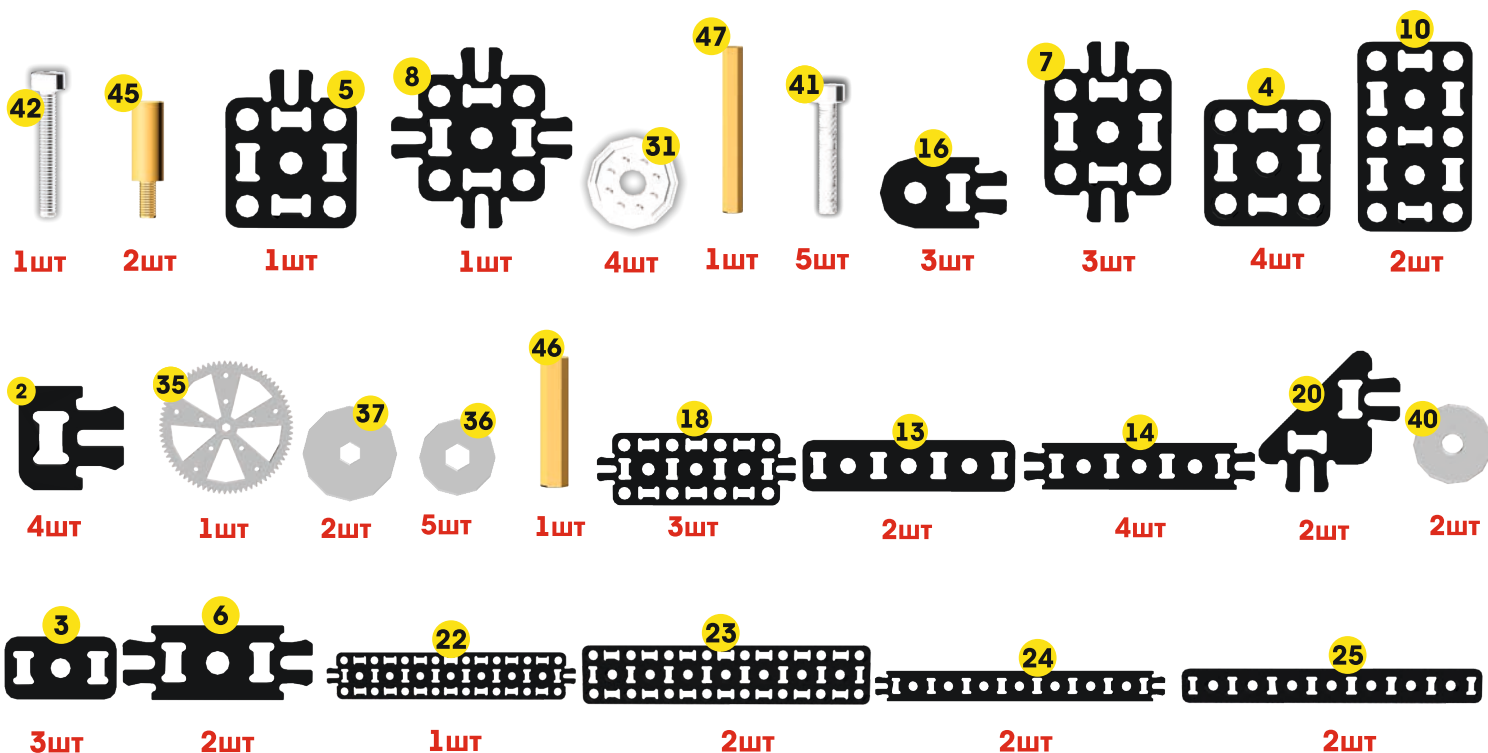

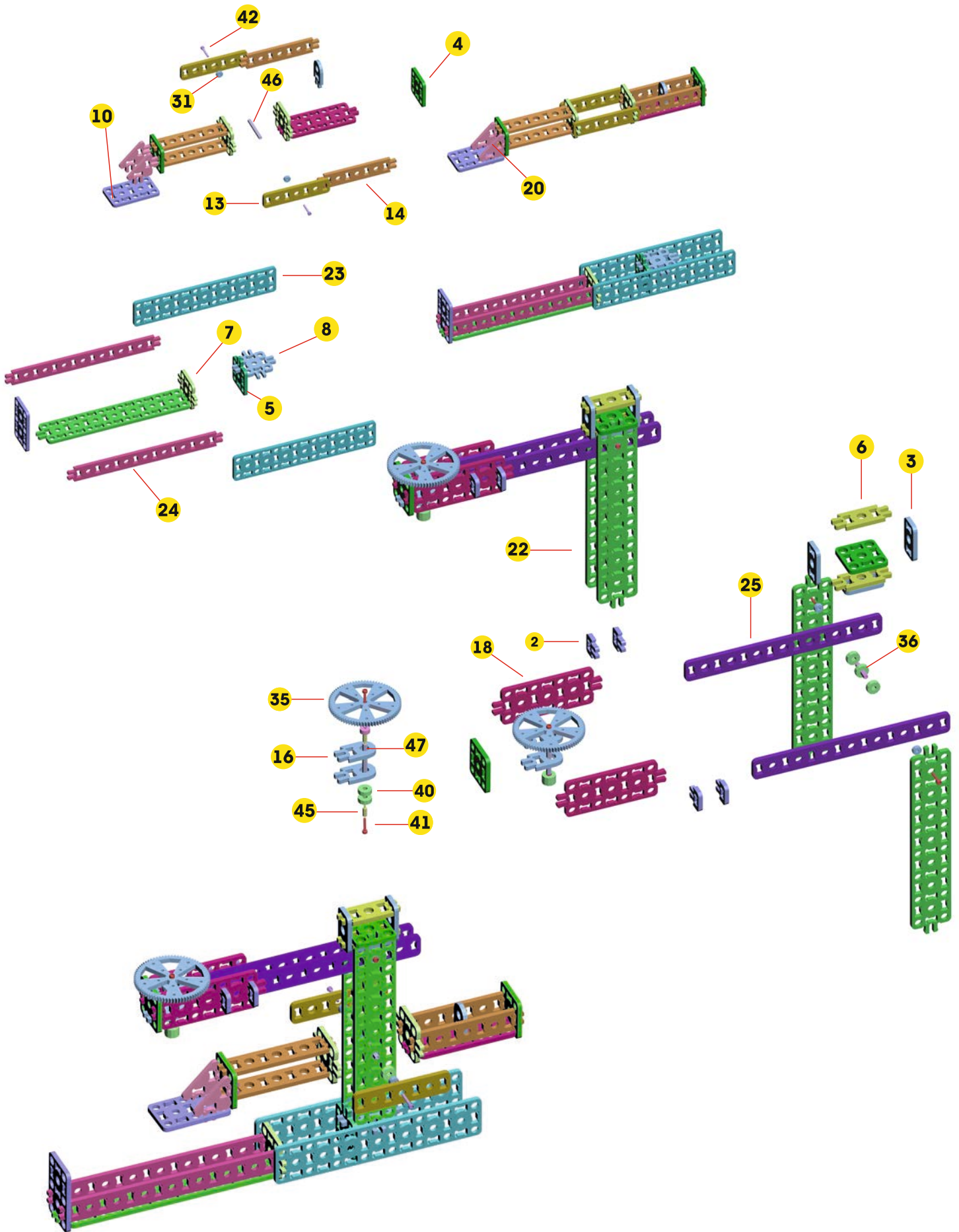

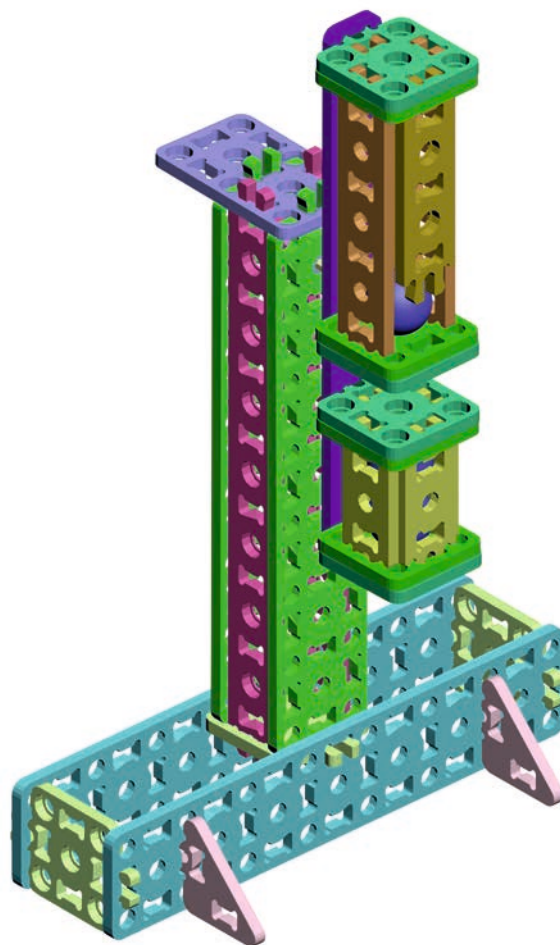
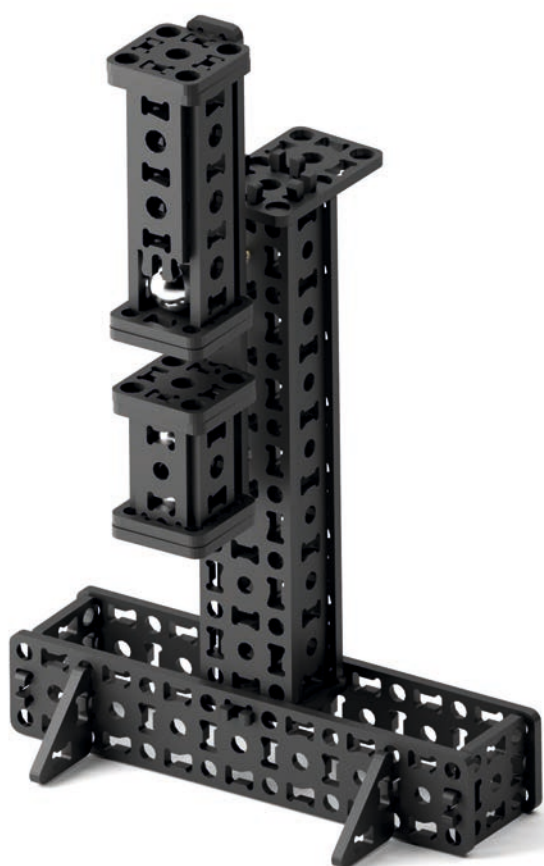

ИСПОЛЬЗУЕМЫЕ ДЕТАЛИ ДЛЯ СБОРКИ

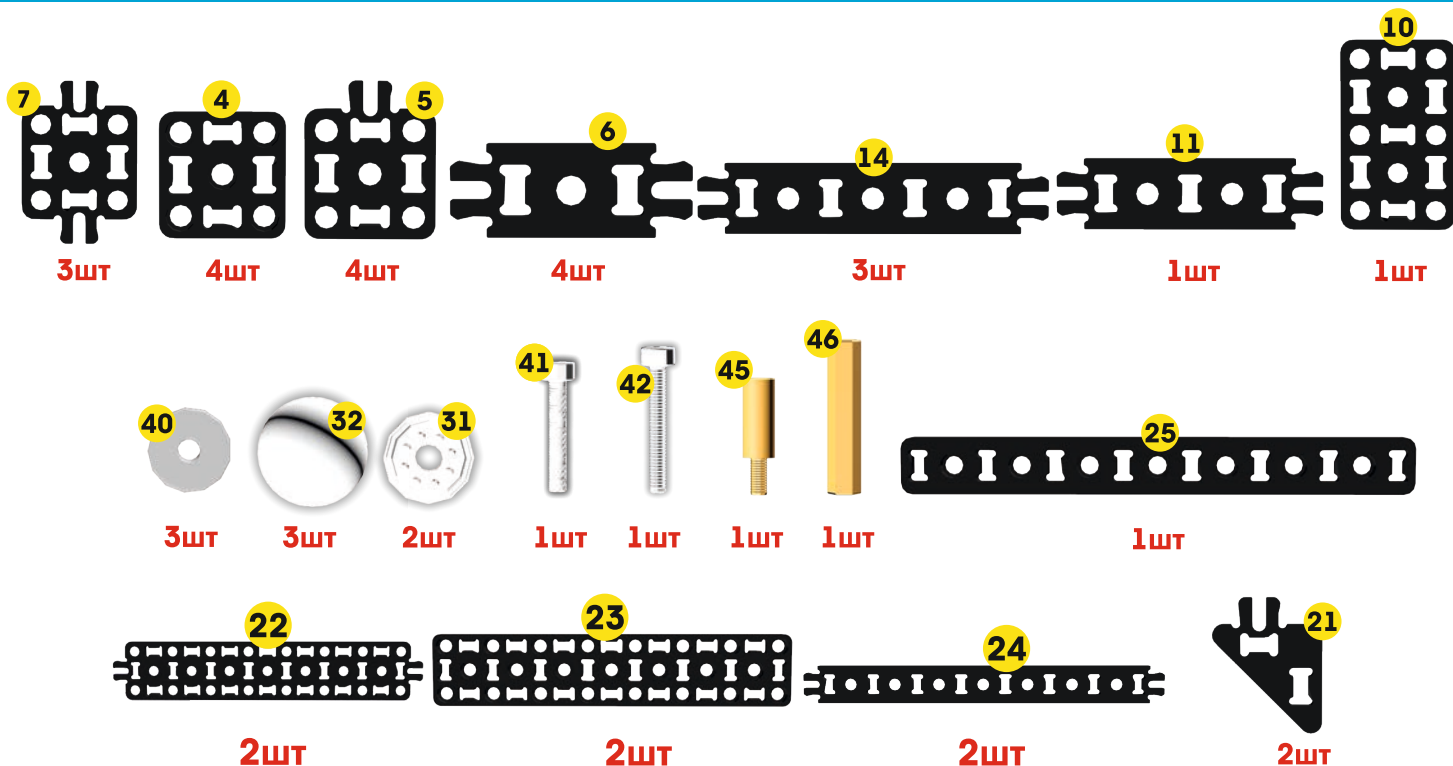

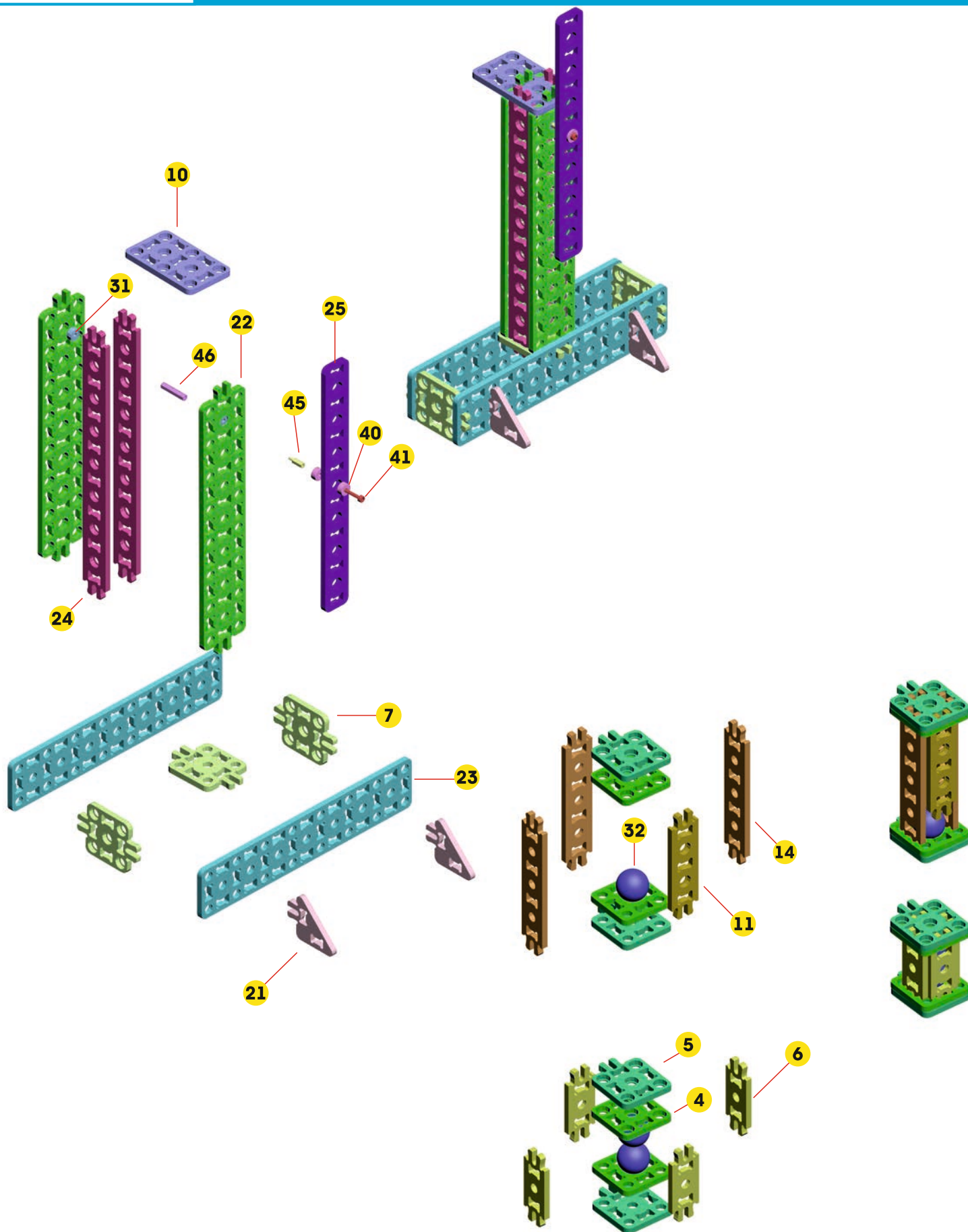

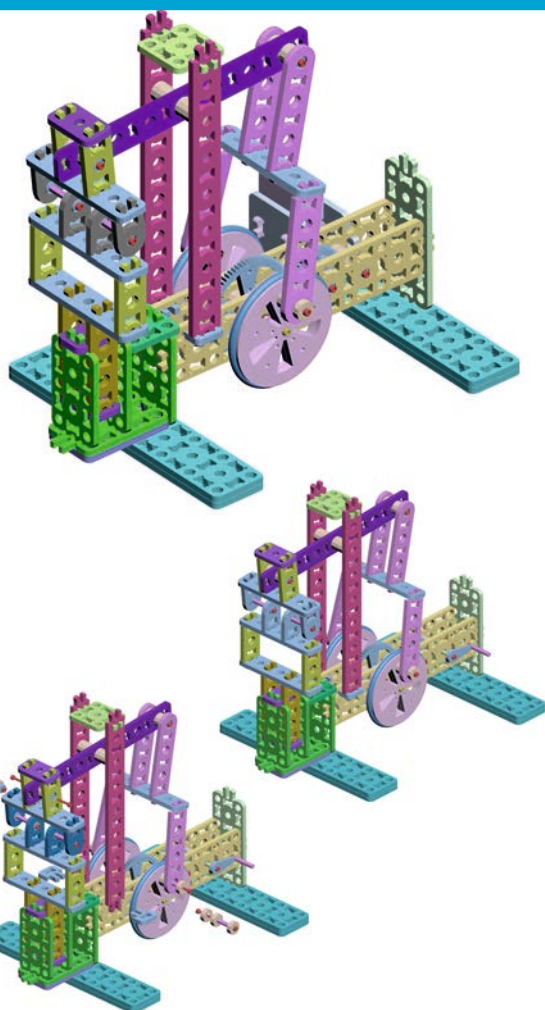
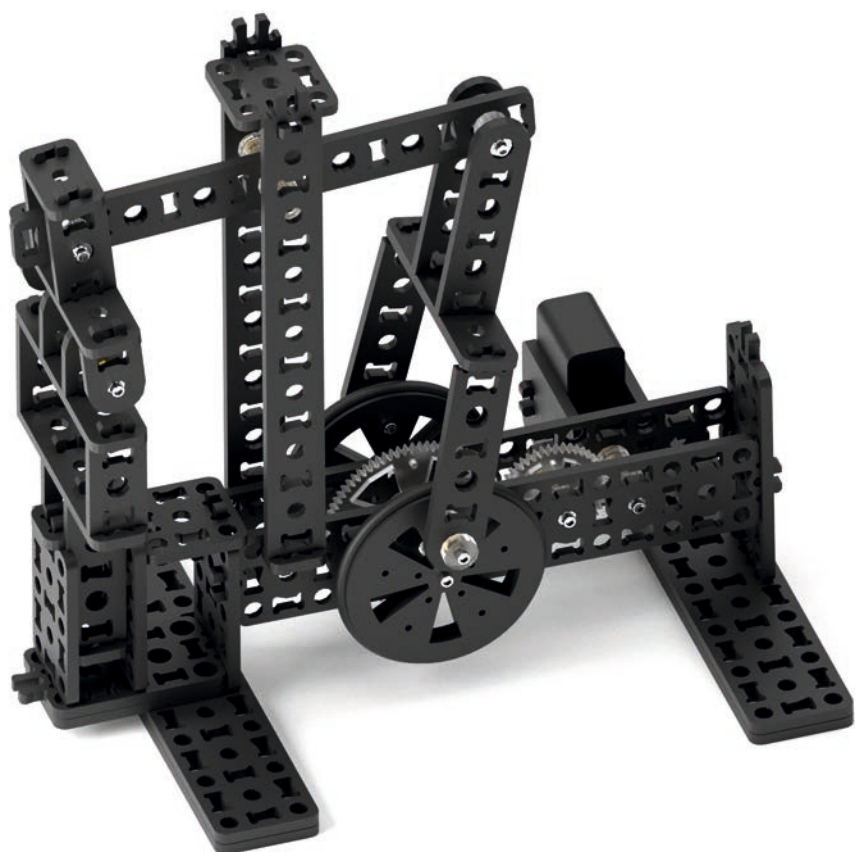

ИСПОЛЬЗУЕМЫЕ ДЕТАЛИ ДЛЯ СБОРКИ

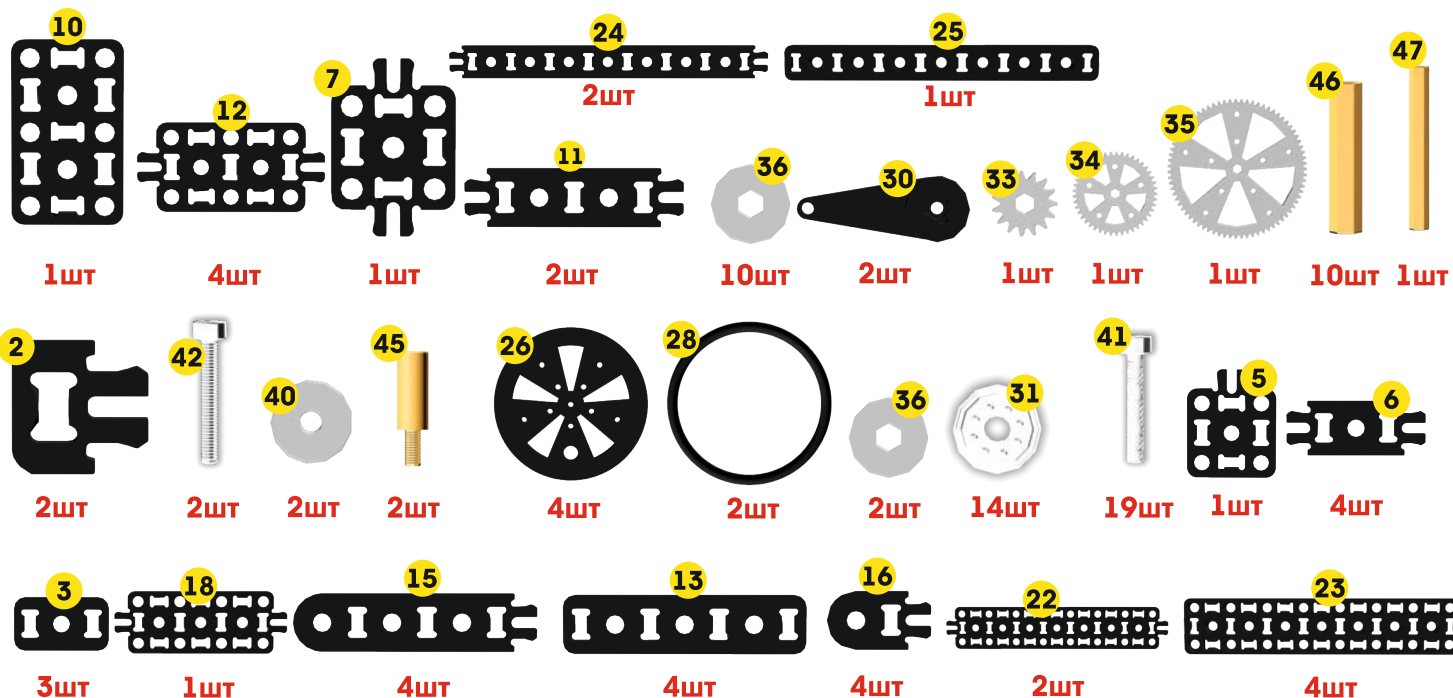

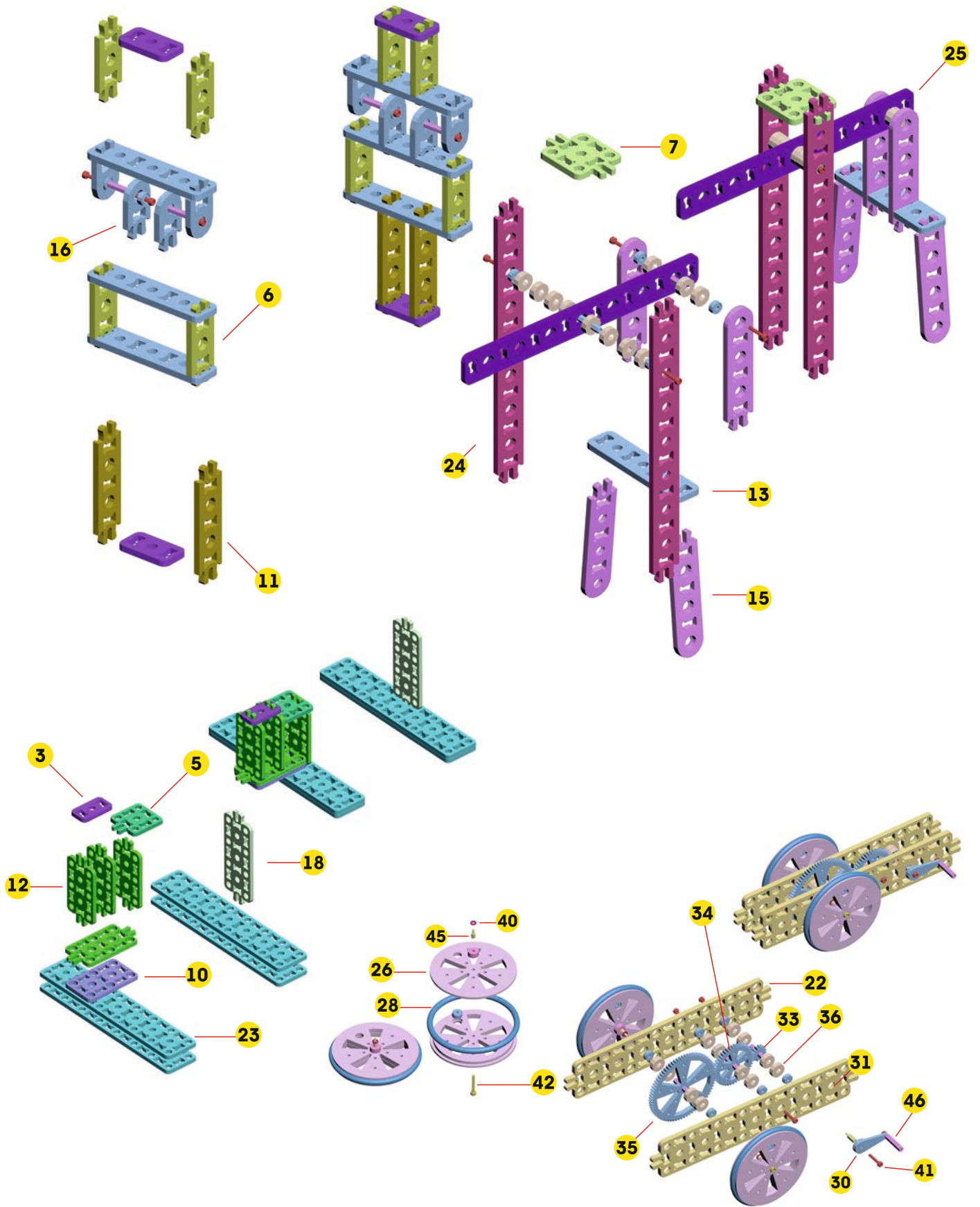

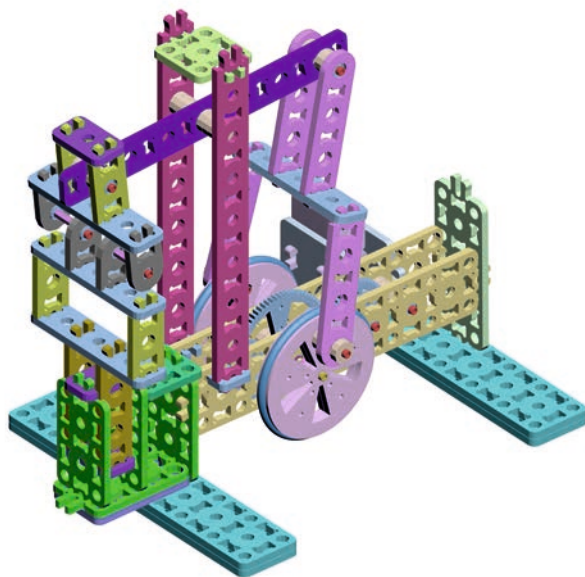
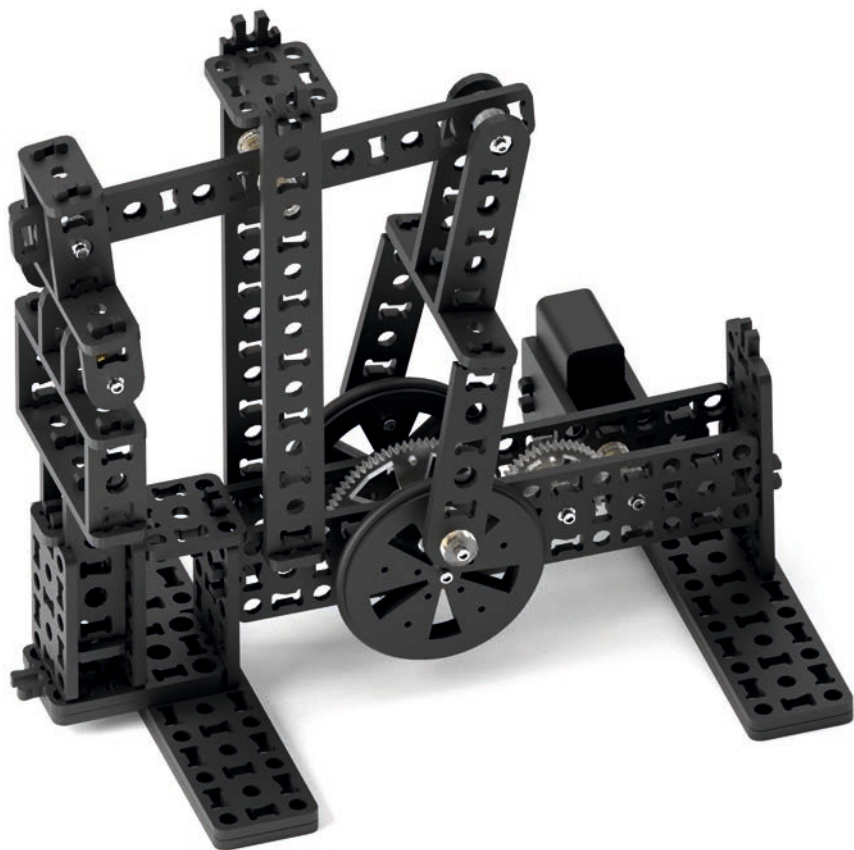

ИСПОЛЬЗУЕМЫЕ ДЕТАЛИ ДЛЯ СБОРКИ

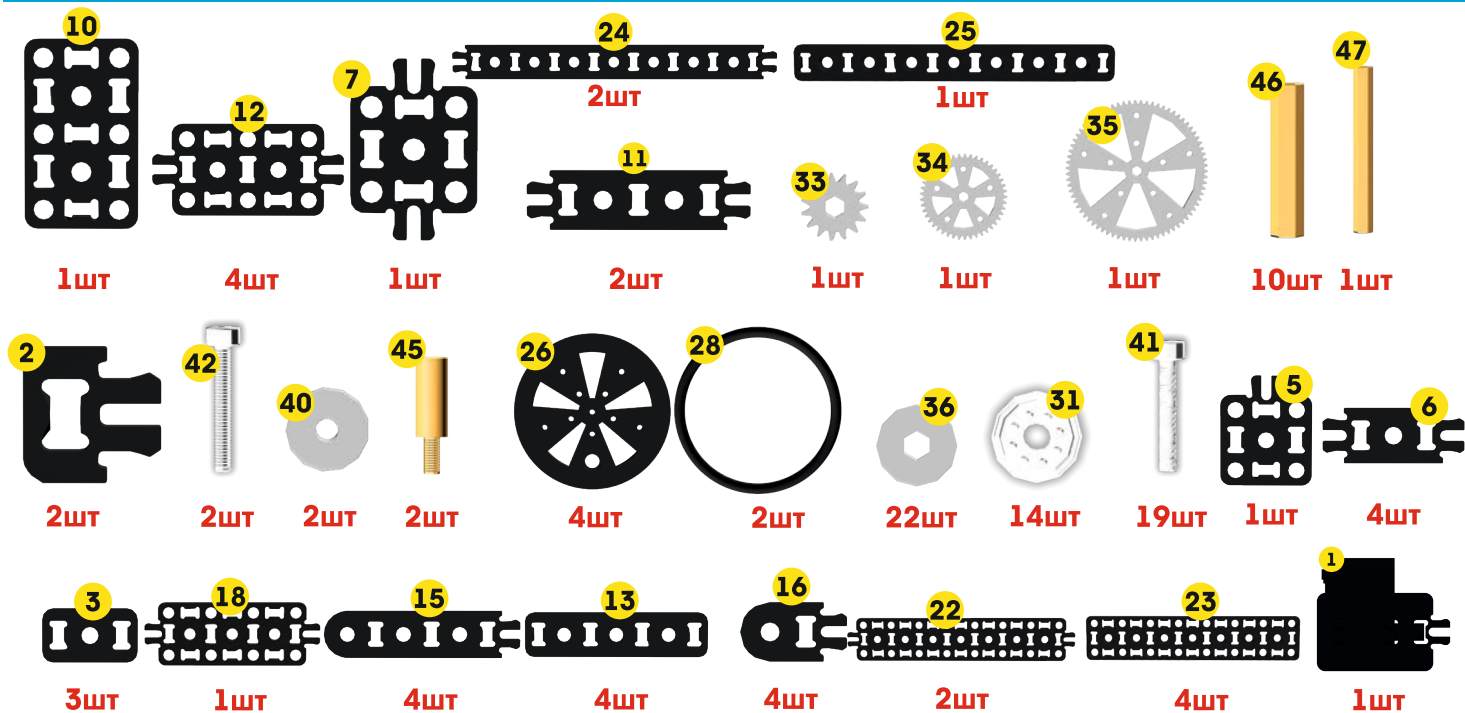

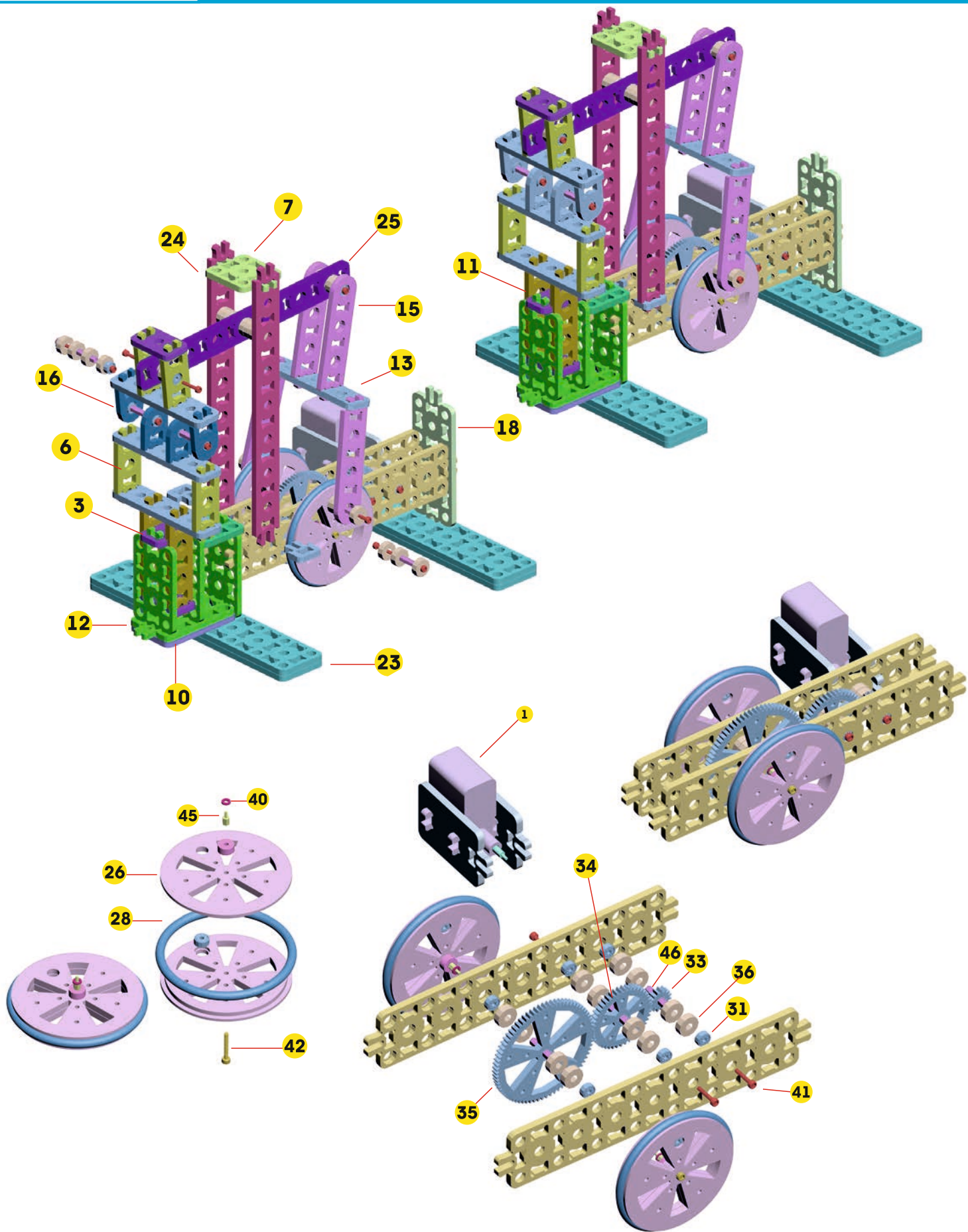

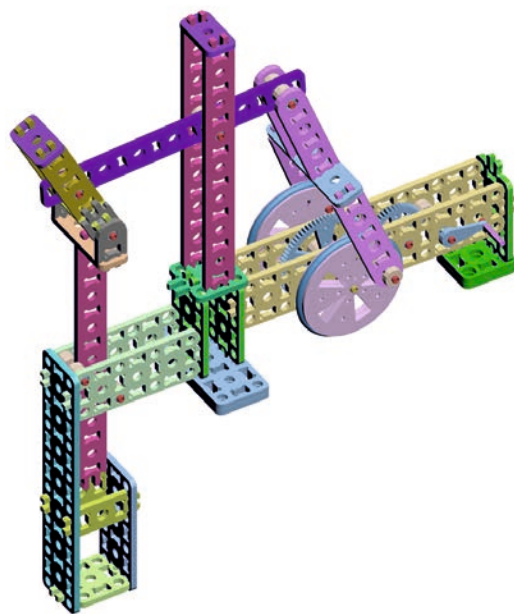
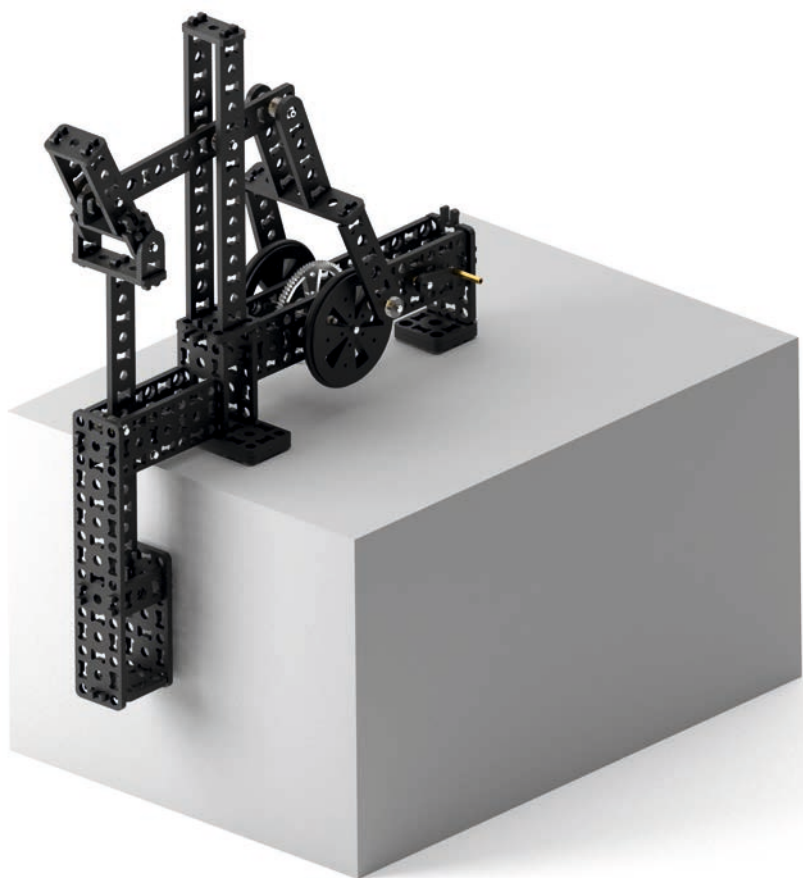

ИСПОЛЬЗУЕМЫЕ ДЕТАЛИ ДЛЯ СБОРКИ

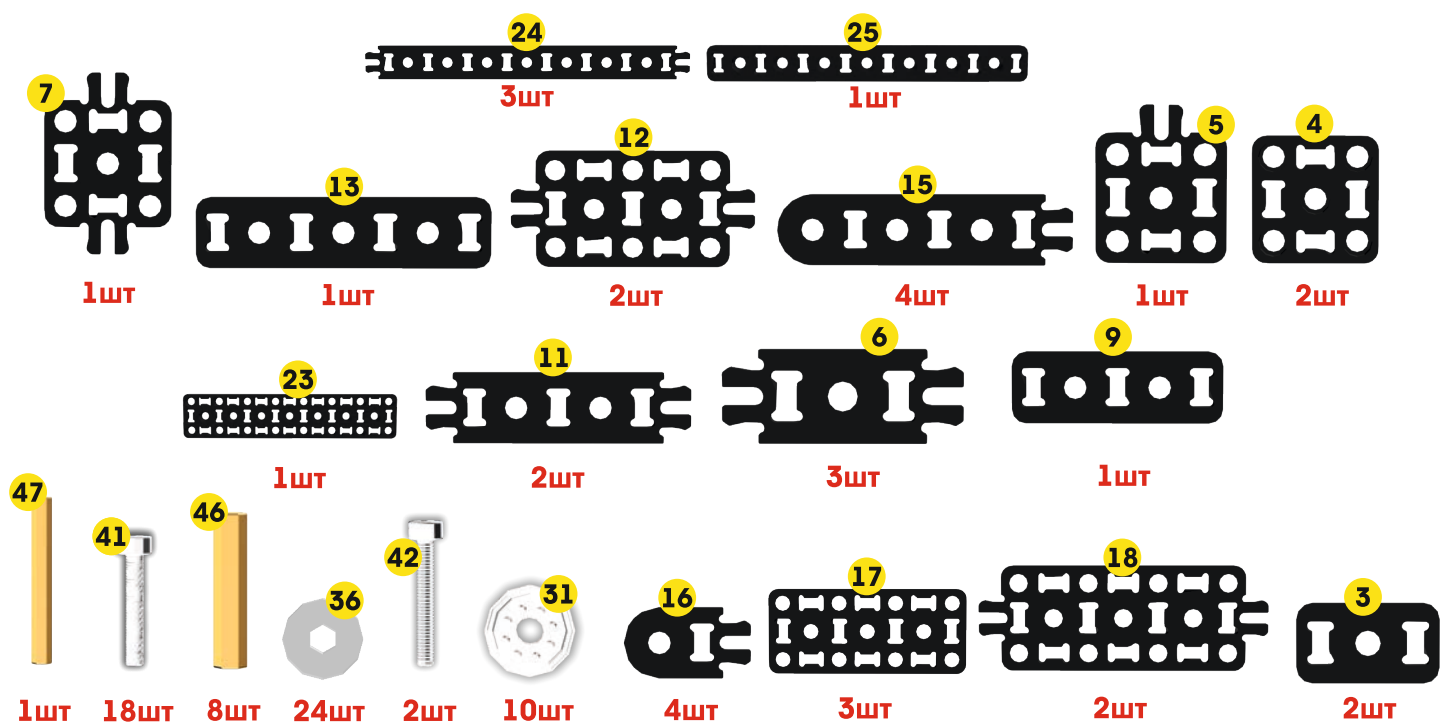

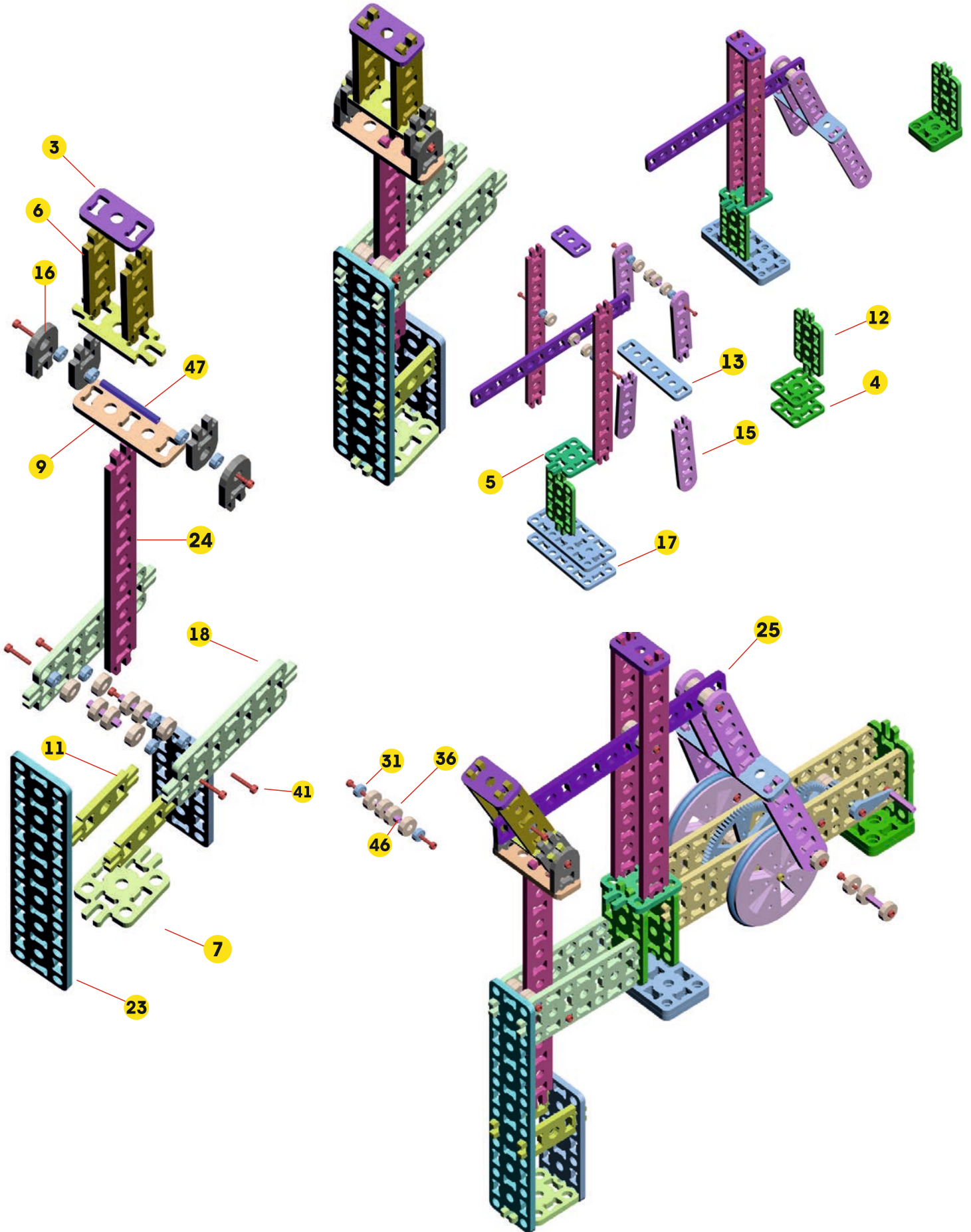

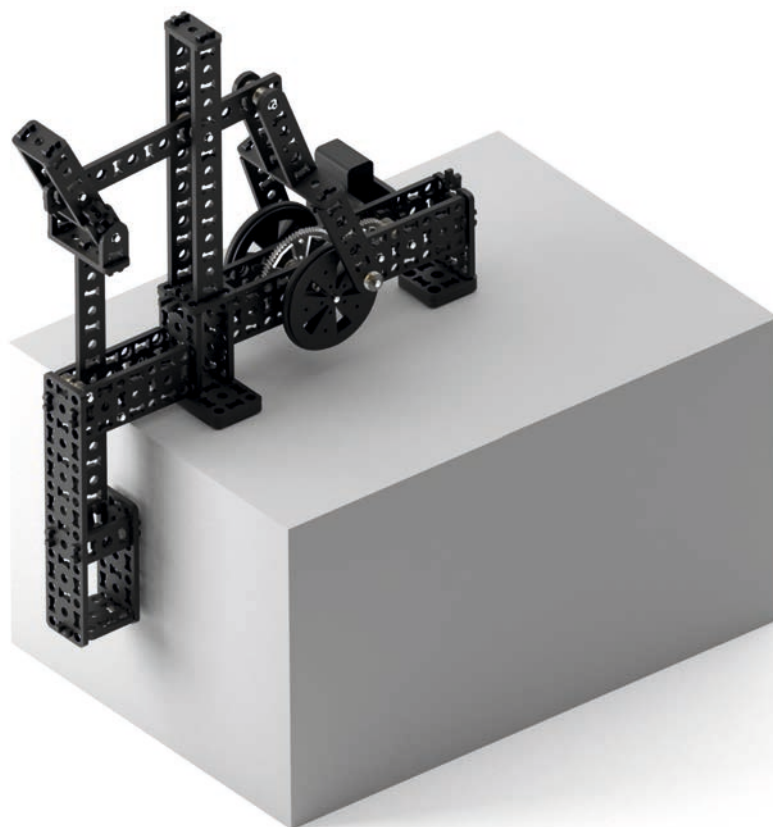

ИСПОЛЬЗУЕМЫЕ ДЕТАЛИ ДЛЯ СБОРКИ

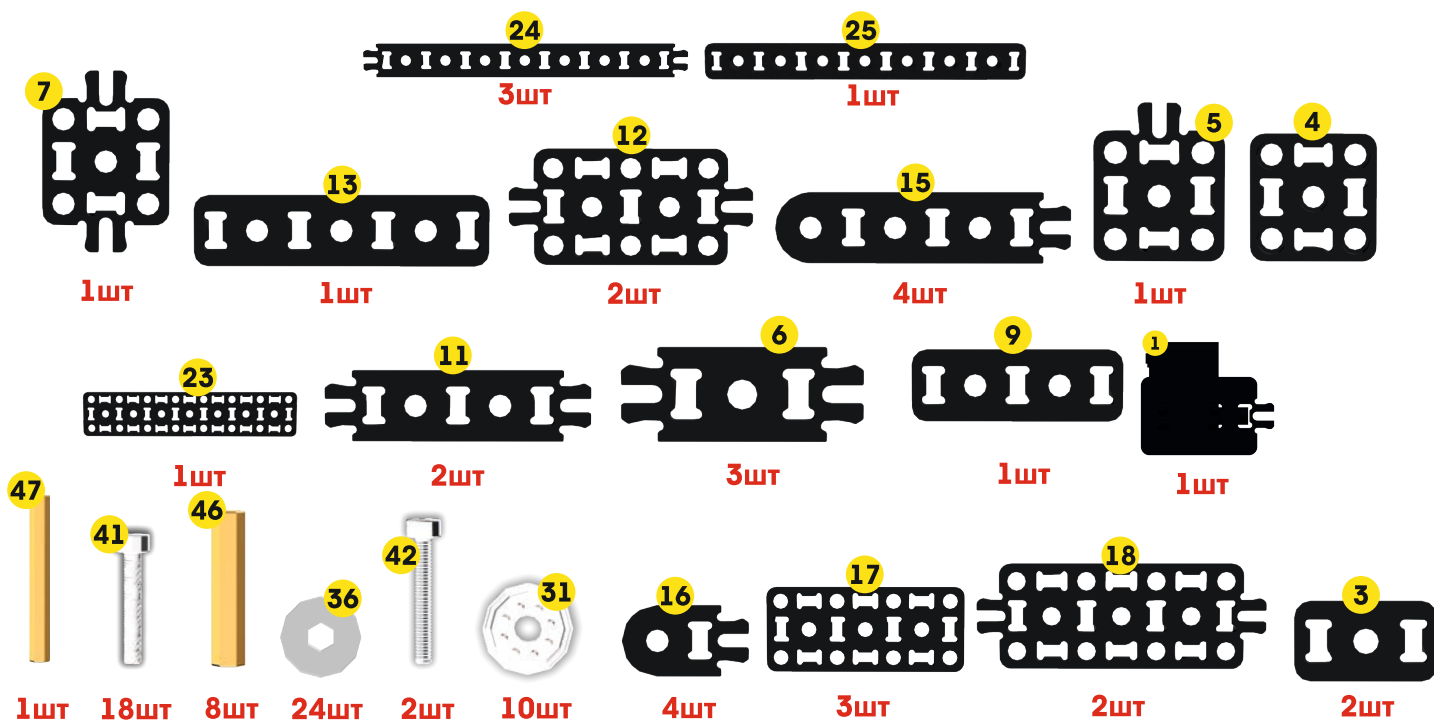

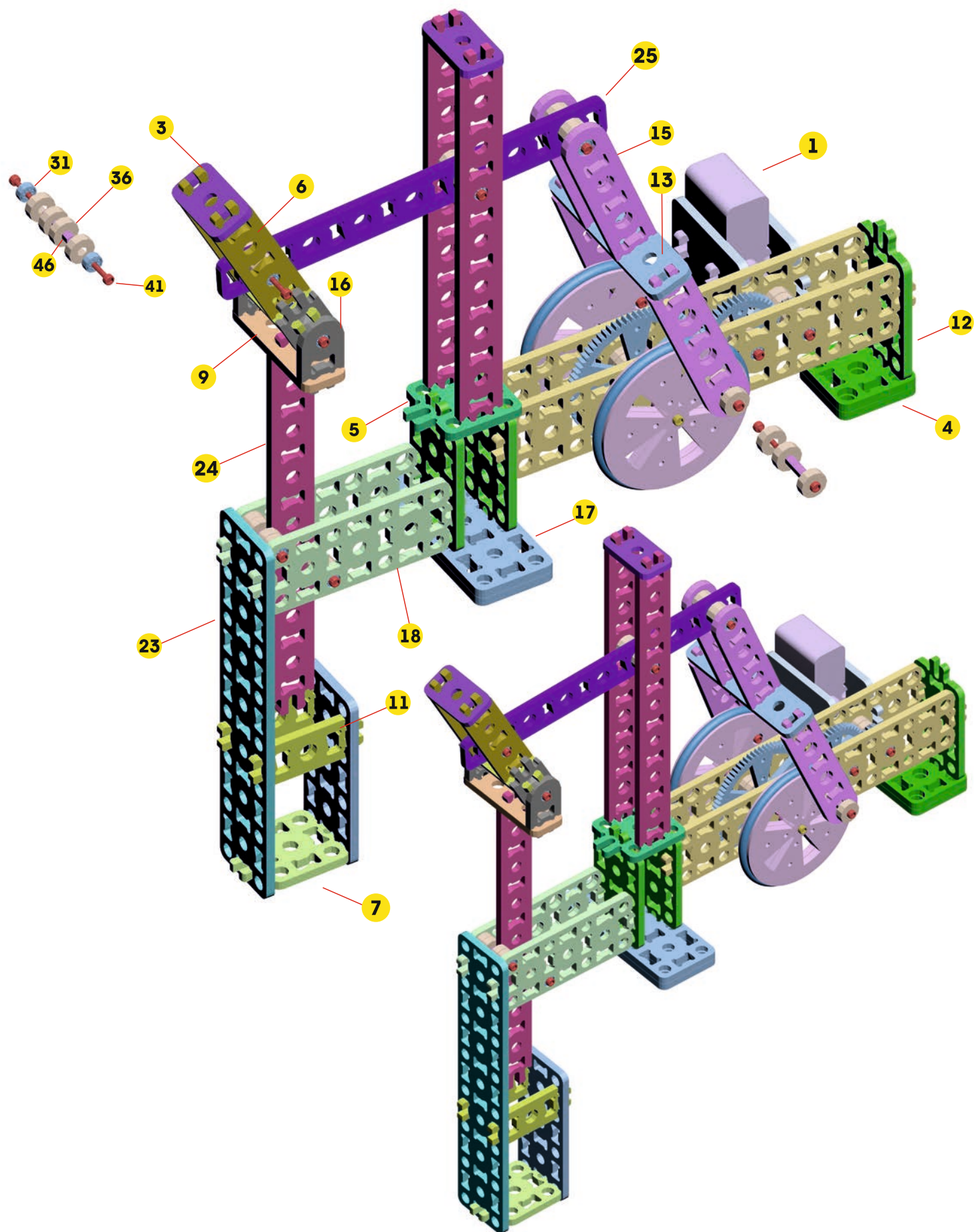

МОДЕЛЬ №20:

МАШИНА НА ТОРСИОННОМ ДВИГАТЕЛЕ С ГИБКИМ РЕДУКТОРОМ

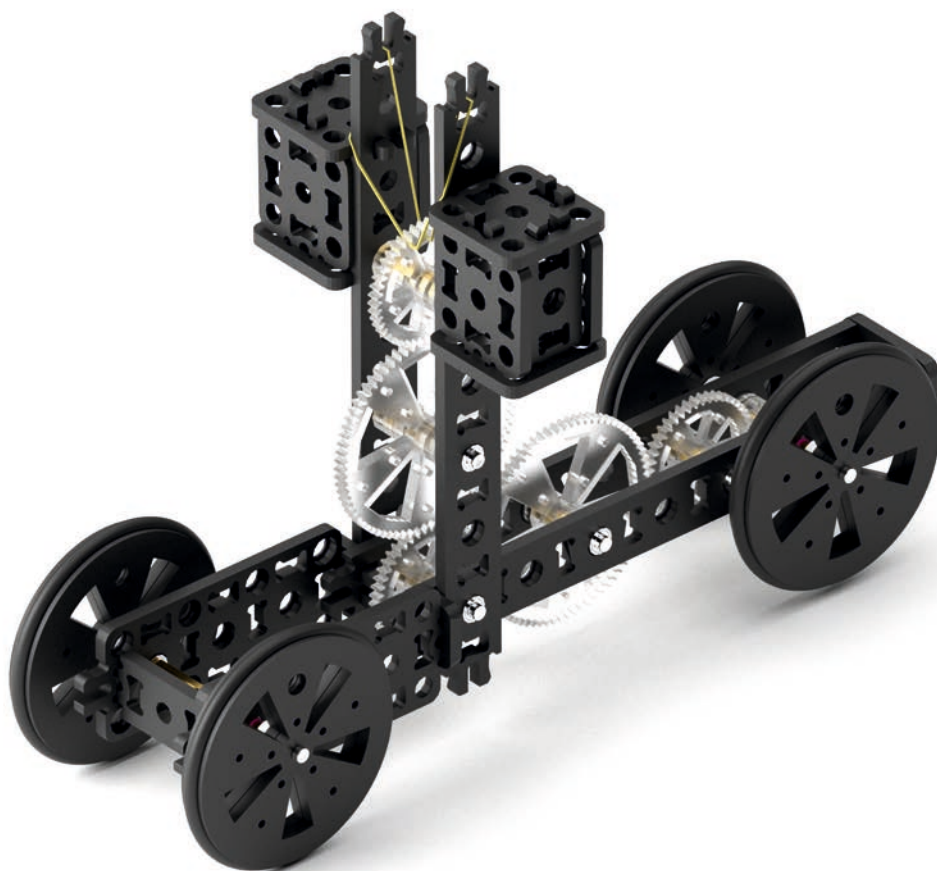

ИСПОЛЬЗУЕМЫЕ ДЕТАЛИ ДЛЯ СБОРКИ

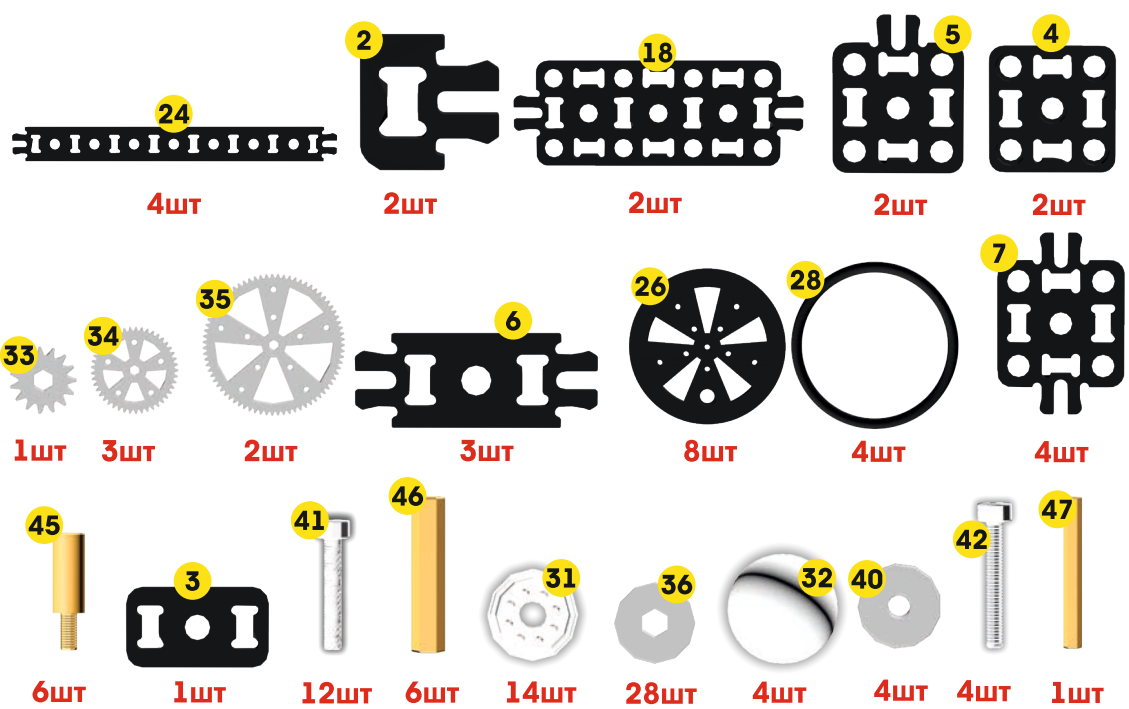

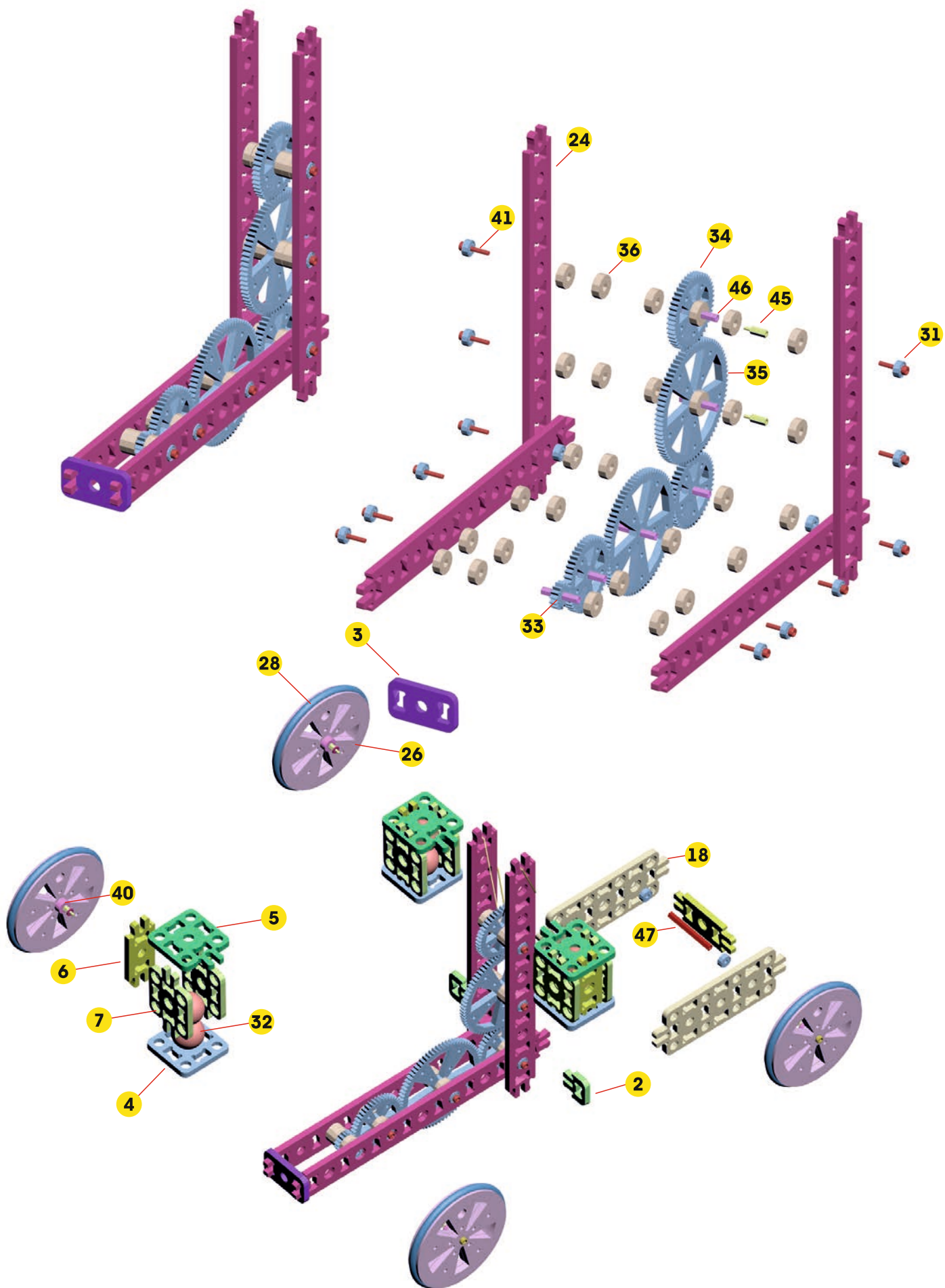



ИСПОЛЬЗУЕМЫЕ ДЕТАЛИ ДЛЯ СБОРКИ

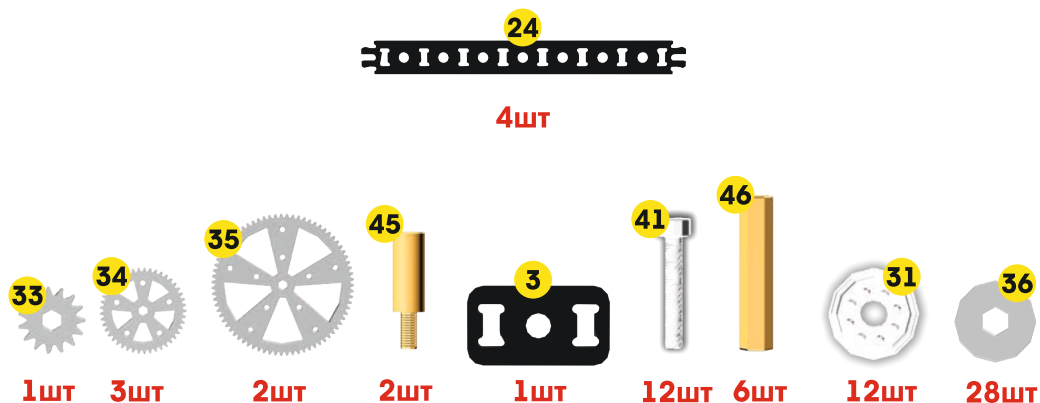

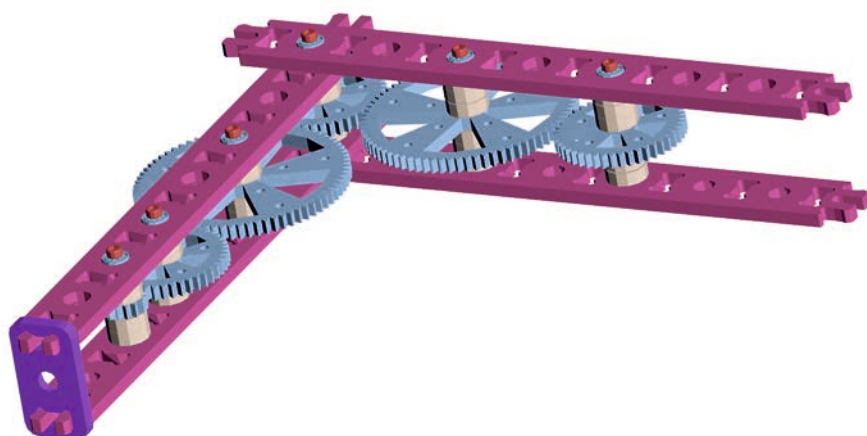
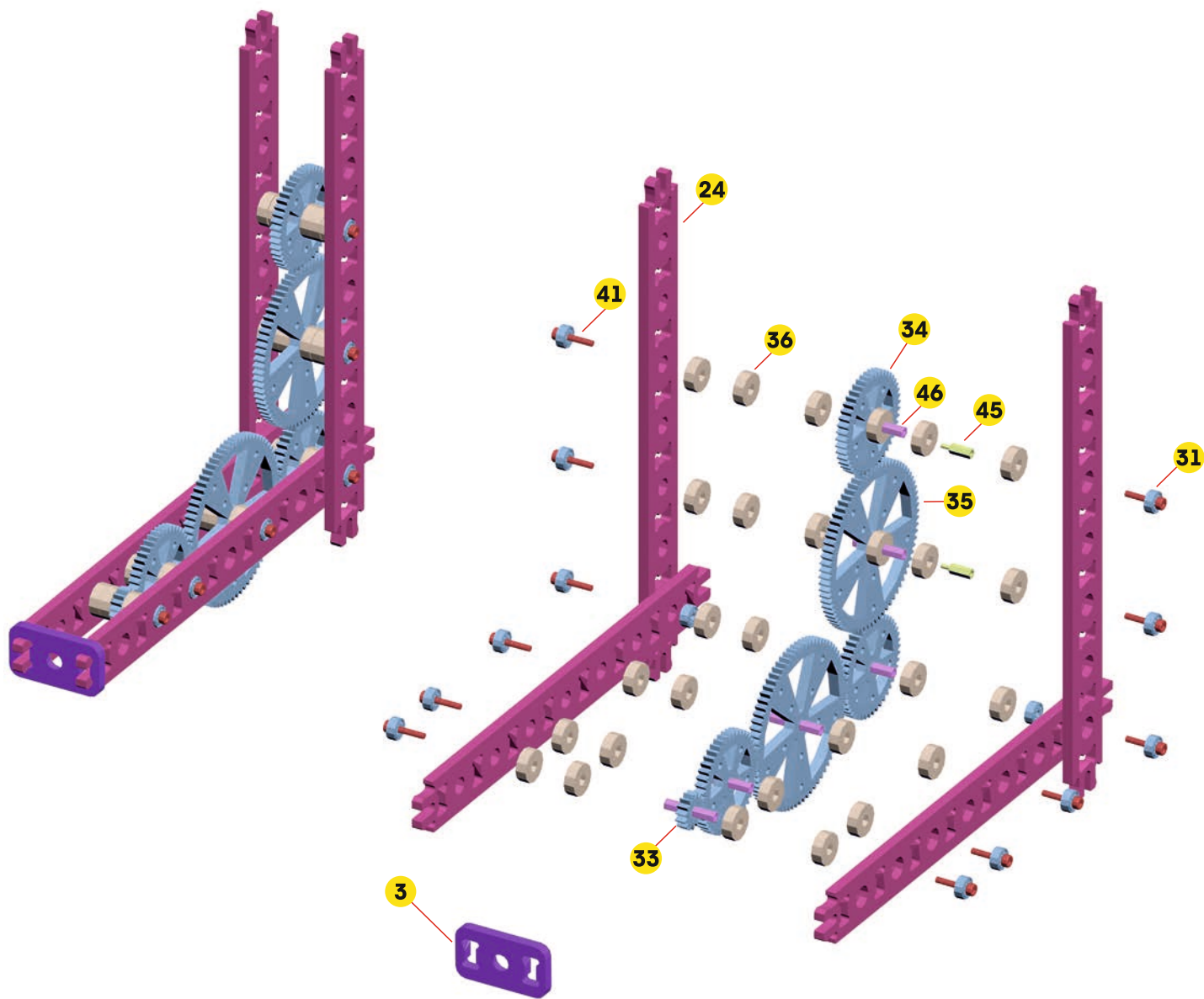

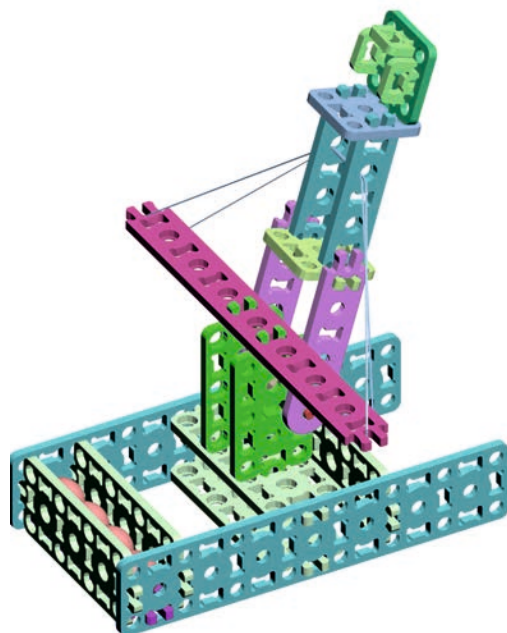

ИСПОЛЬЗУЕМЫЕ ДЕТАЛИ ДЛЯ СБОРКИ



2шт



1шт



3шт



1шт



1шт



2шт



4шт



2шт

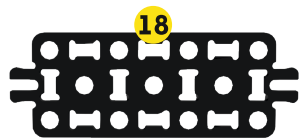

4шт

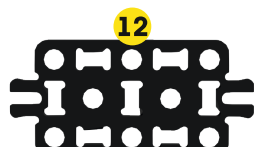

2шт



2шт



2шт



7шт



4шт



1шт

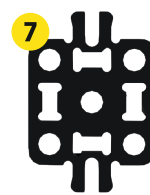

2шт

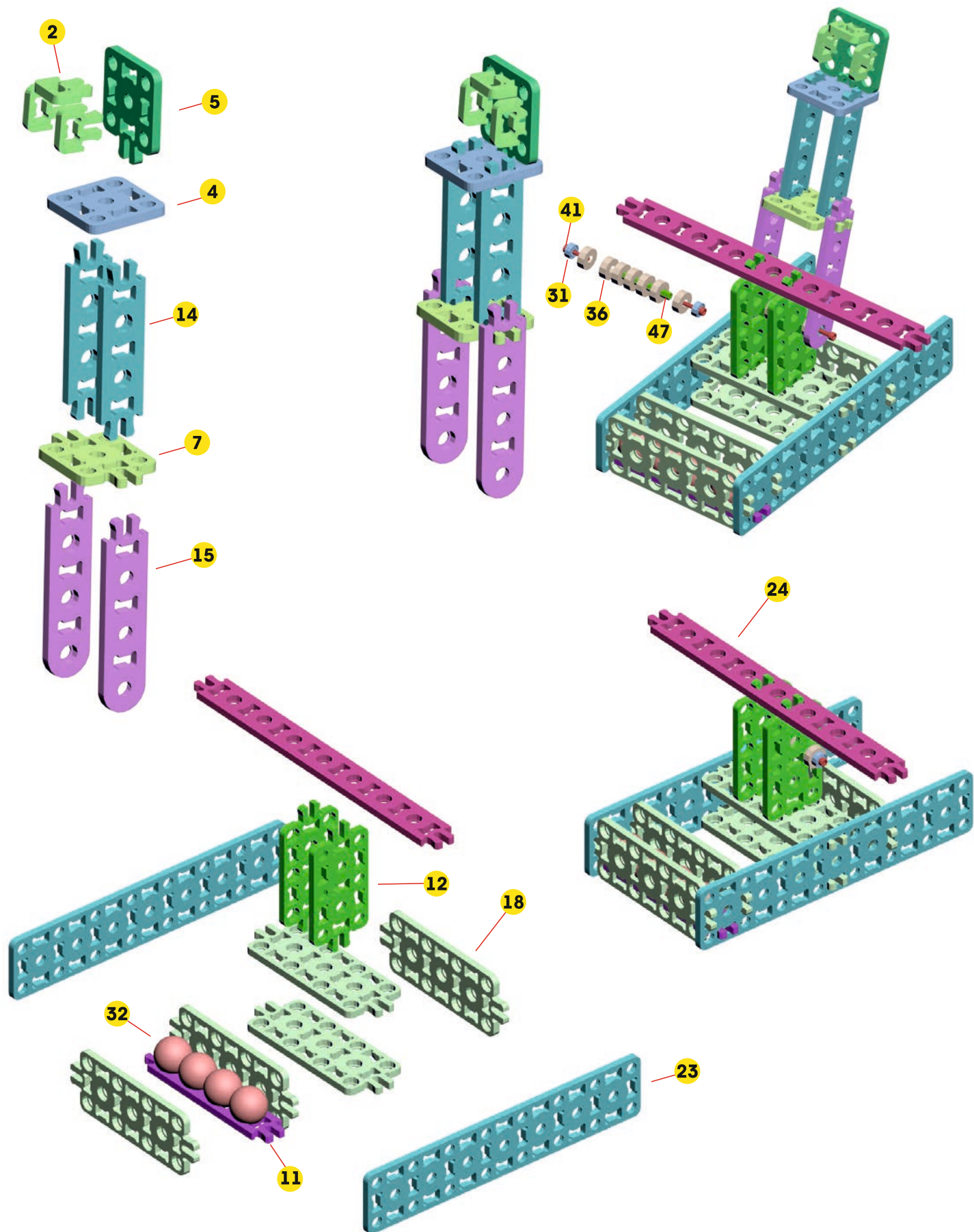

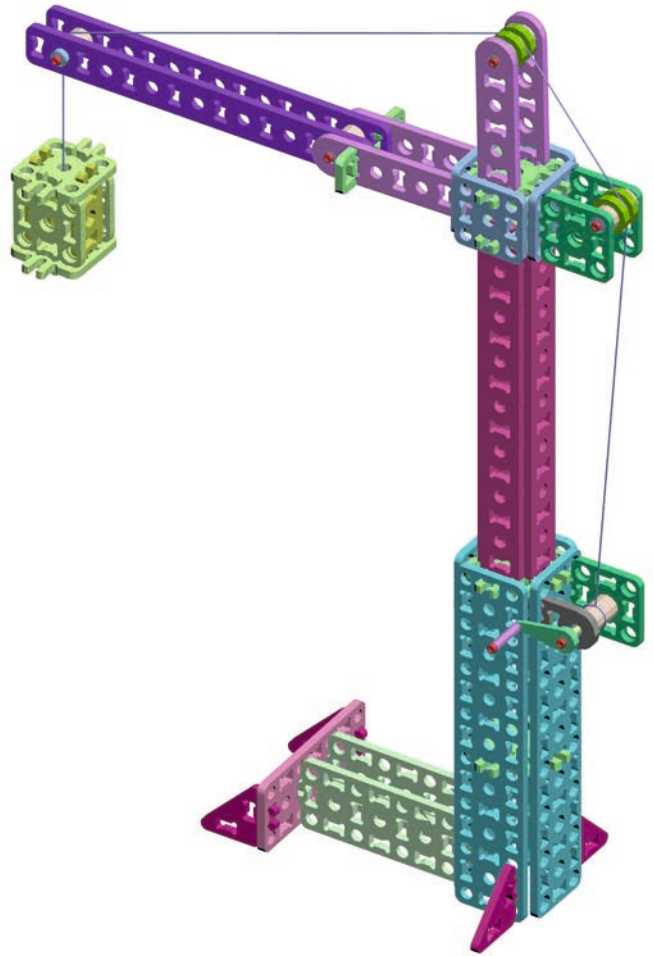

ИСПОЛЬЗУЕМЫЕ ДЕТАЛИ ДЛЯ СБОРКИ



25

2шт



24

4шт



5

3шт



4

4шт

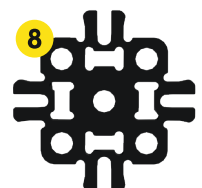

8

4шт



6

2шт



15

4шт



46

6шт



23

4шт



21

4шт



16

1шт



30

1шт



7

4шт



36

12шт



41

11шт



45

1шт



37

4шт



31

8шт

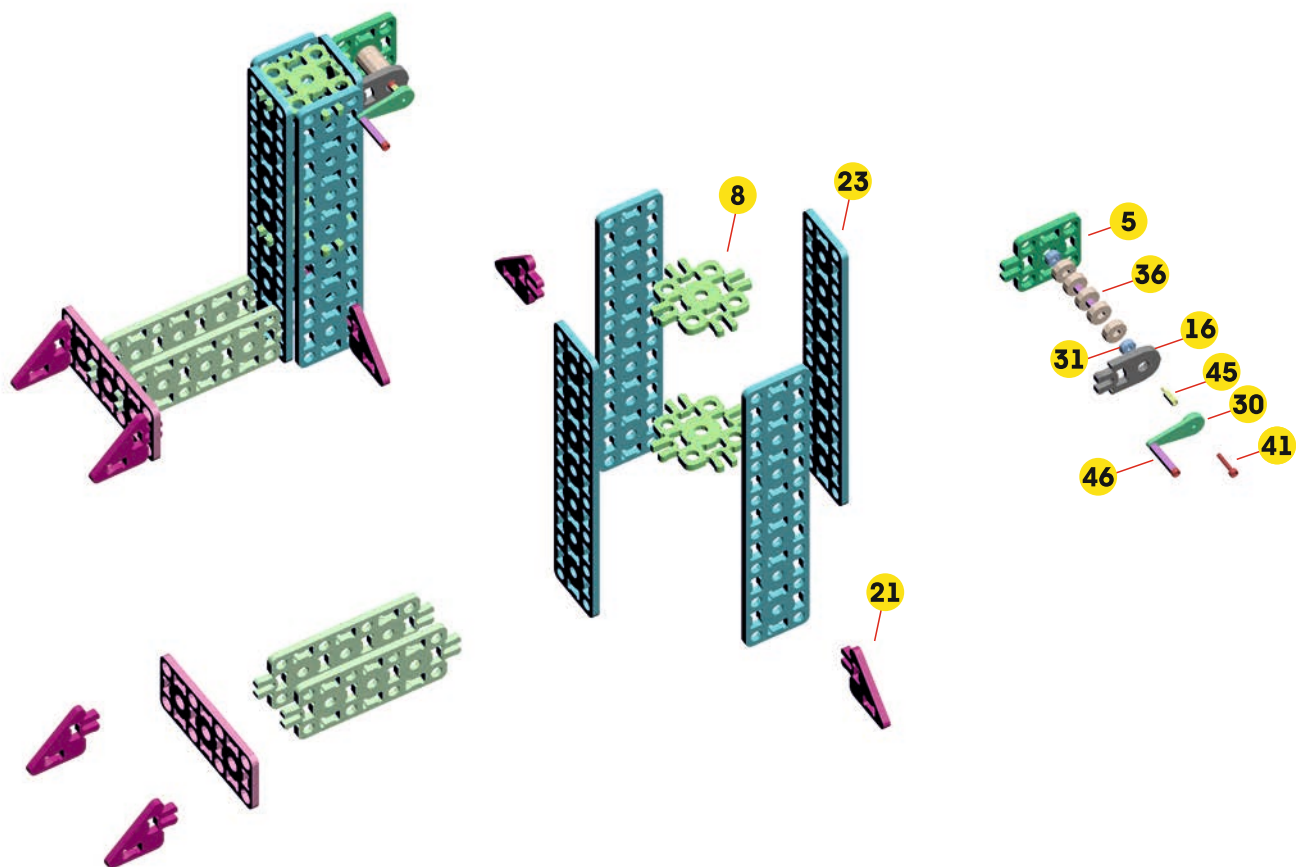
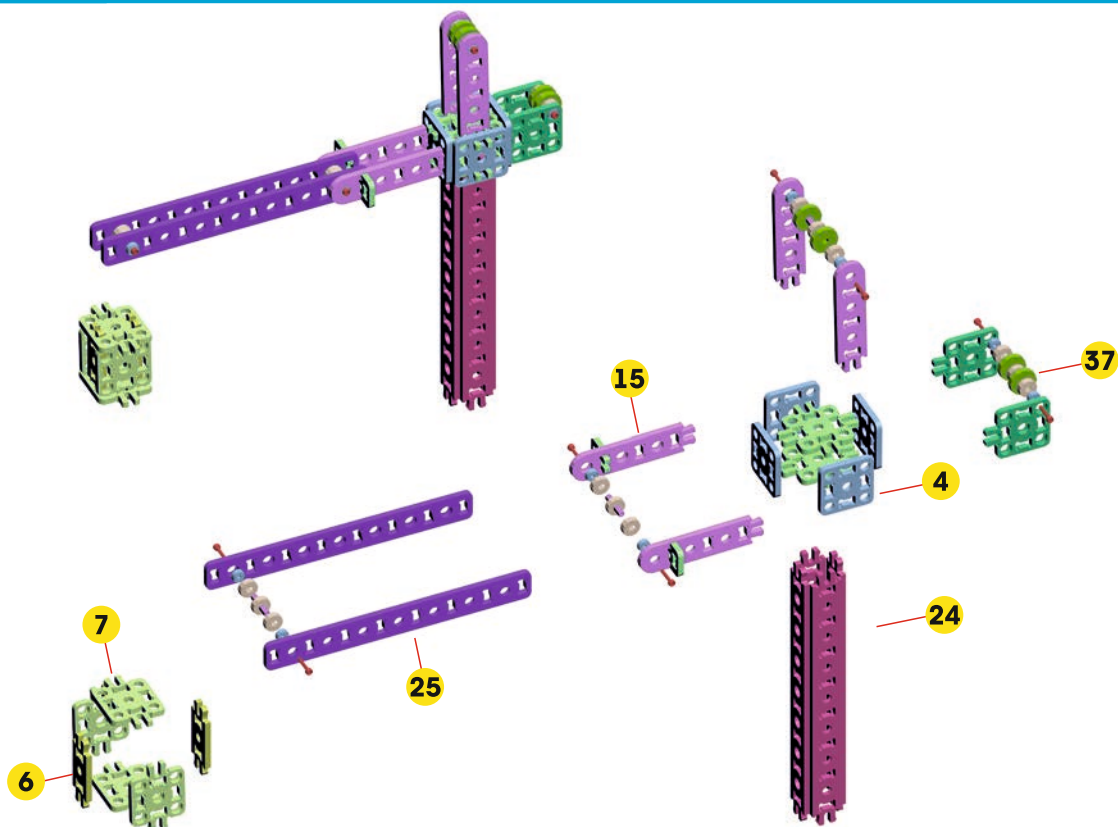

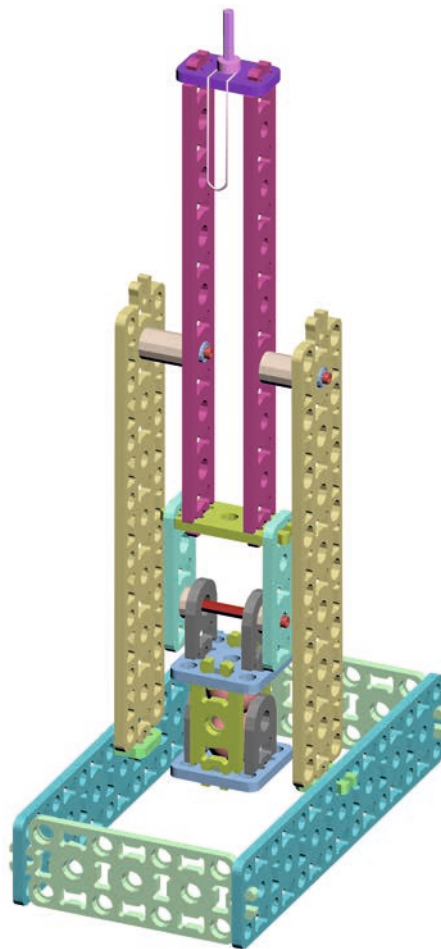

ИСПОЛЬЗУЕМЫЕ ДЕТАЛИ ДЛЯ СБОРКИ

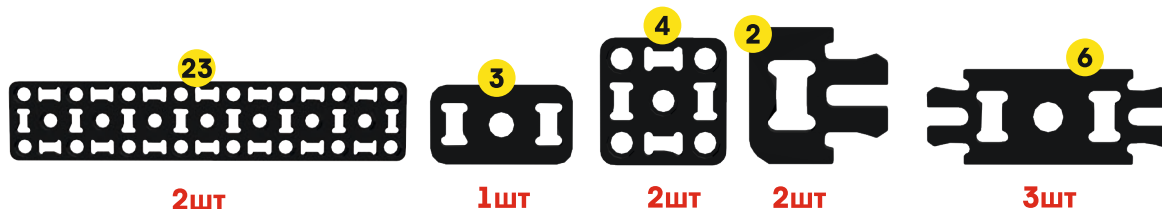
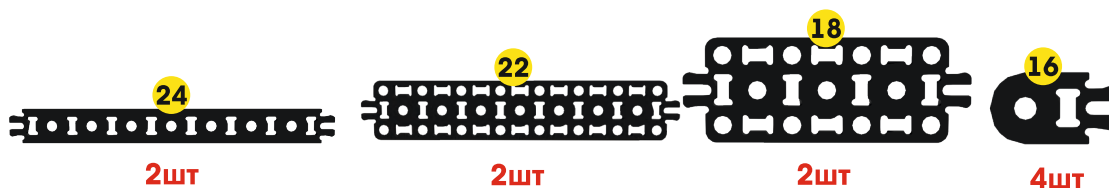

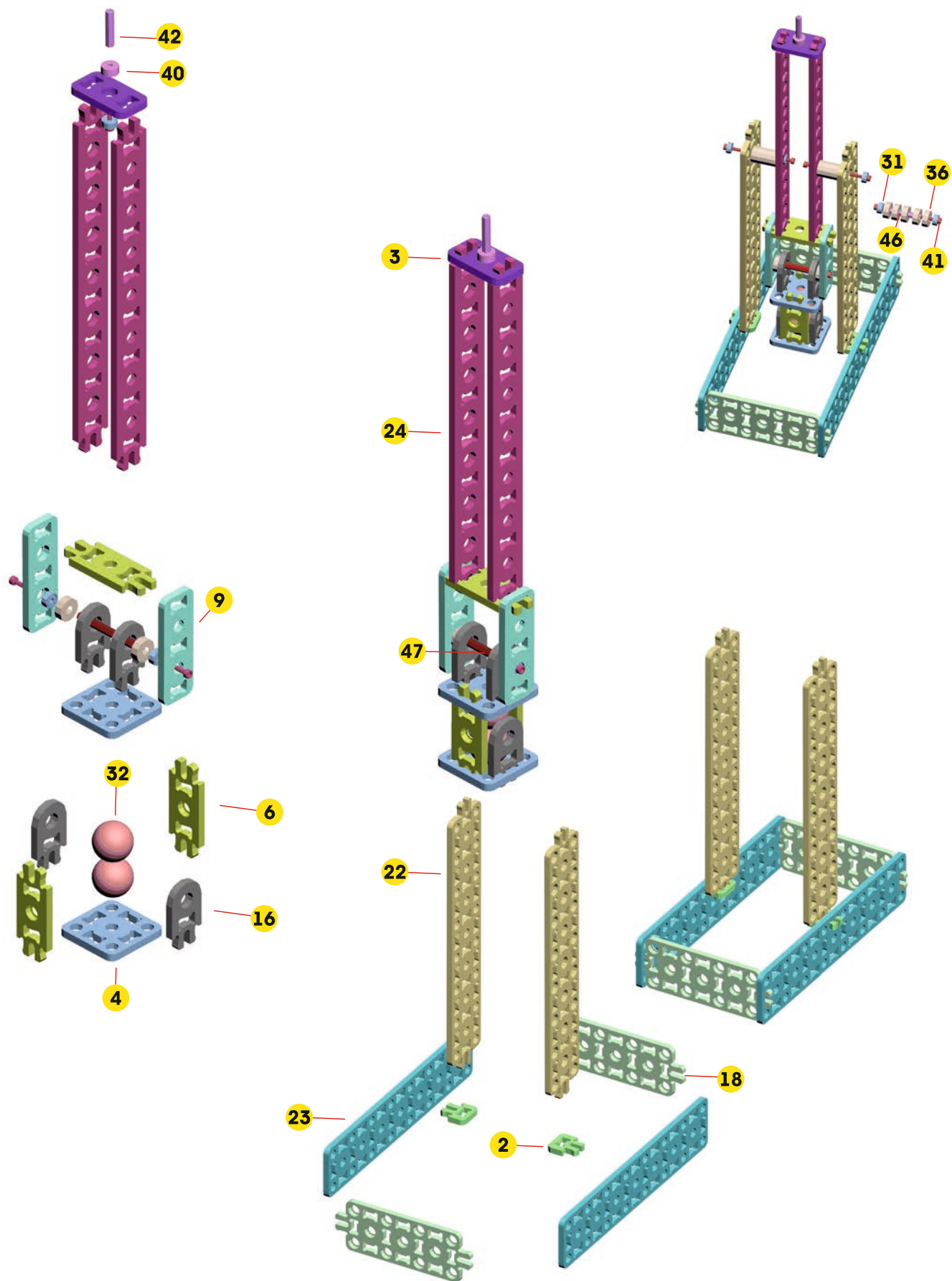

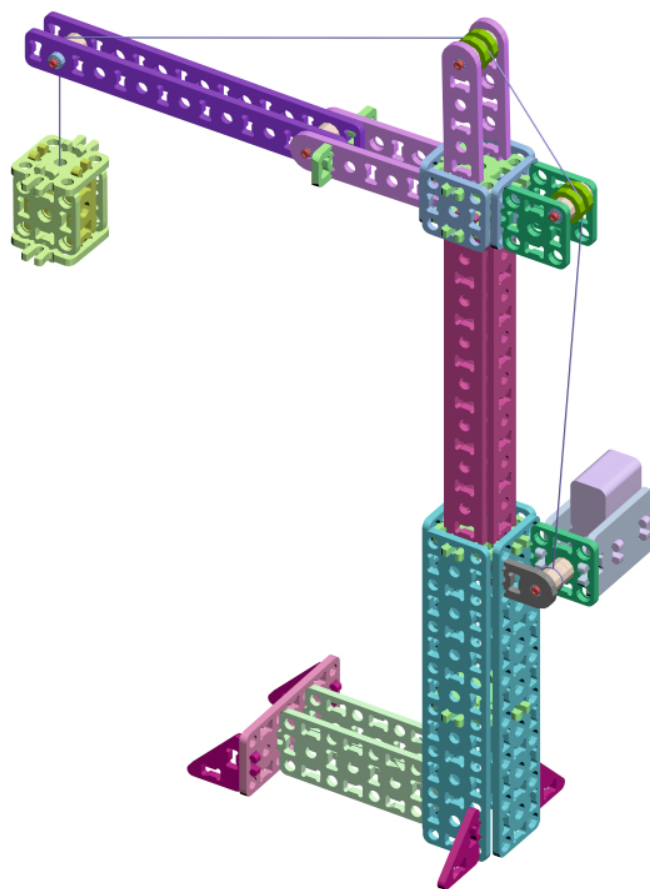
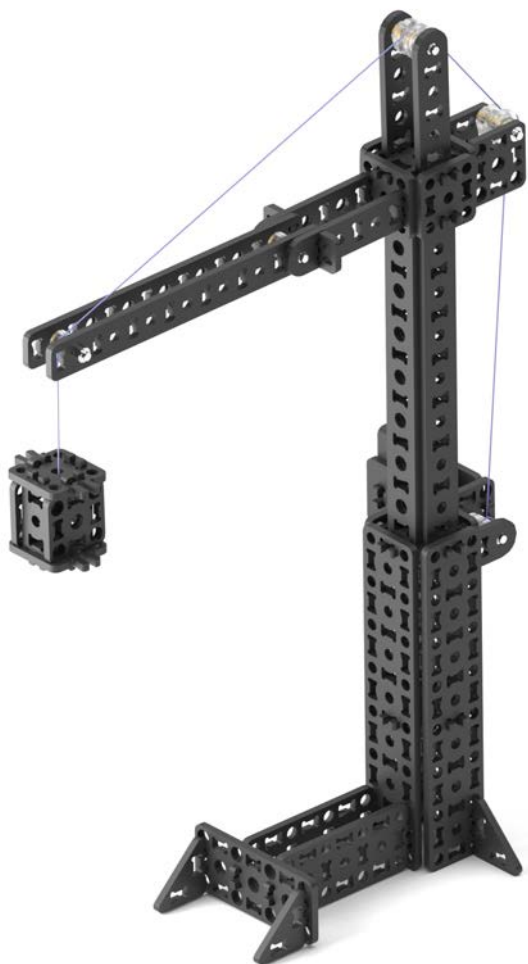

ИСПОЛЬЗУЕМЫЕ ДЕТАЛИ ДЛЯ СБОРКИ

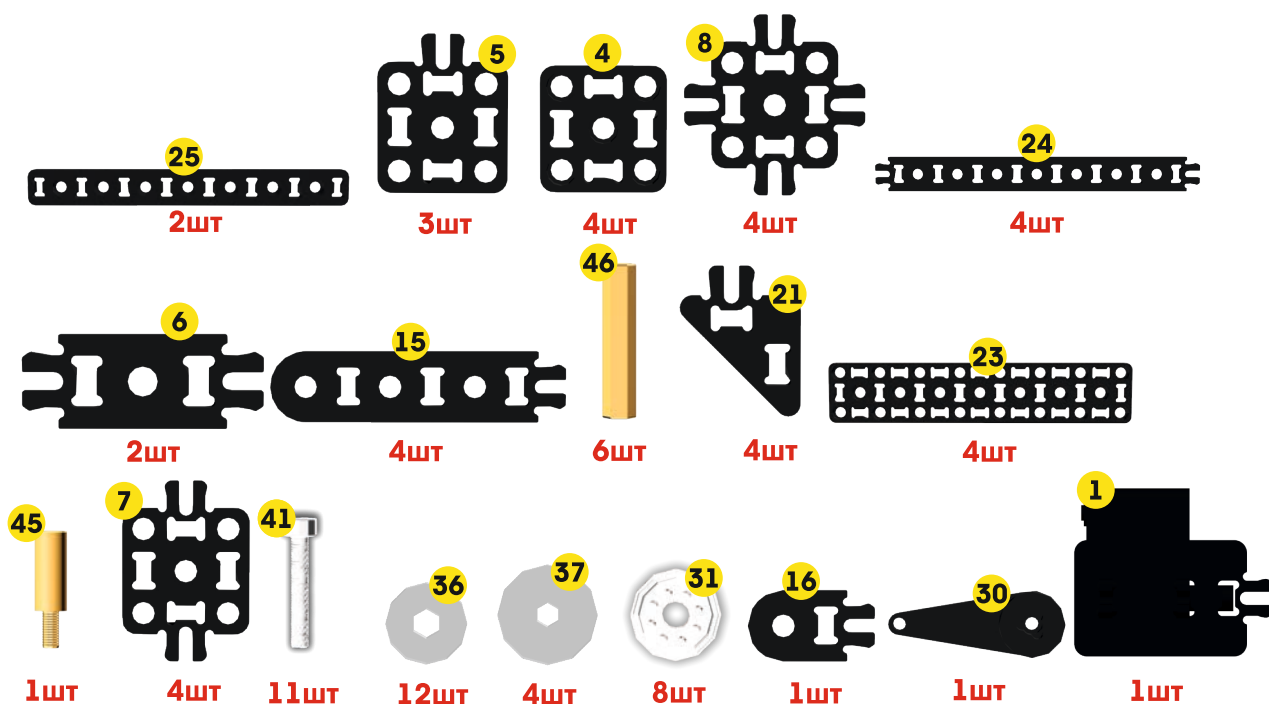

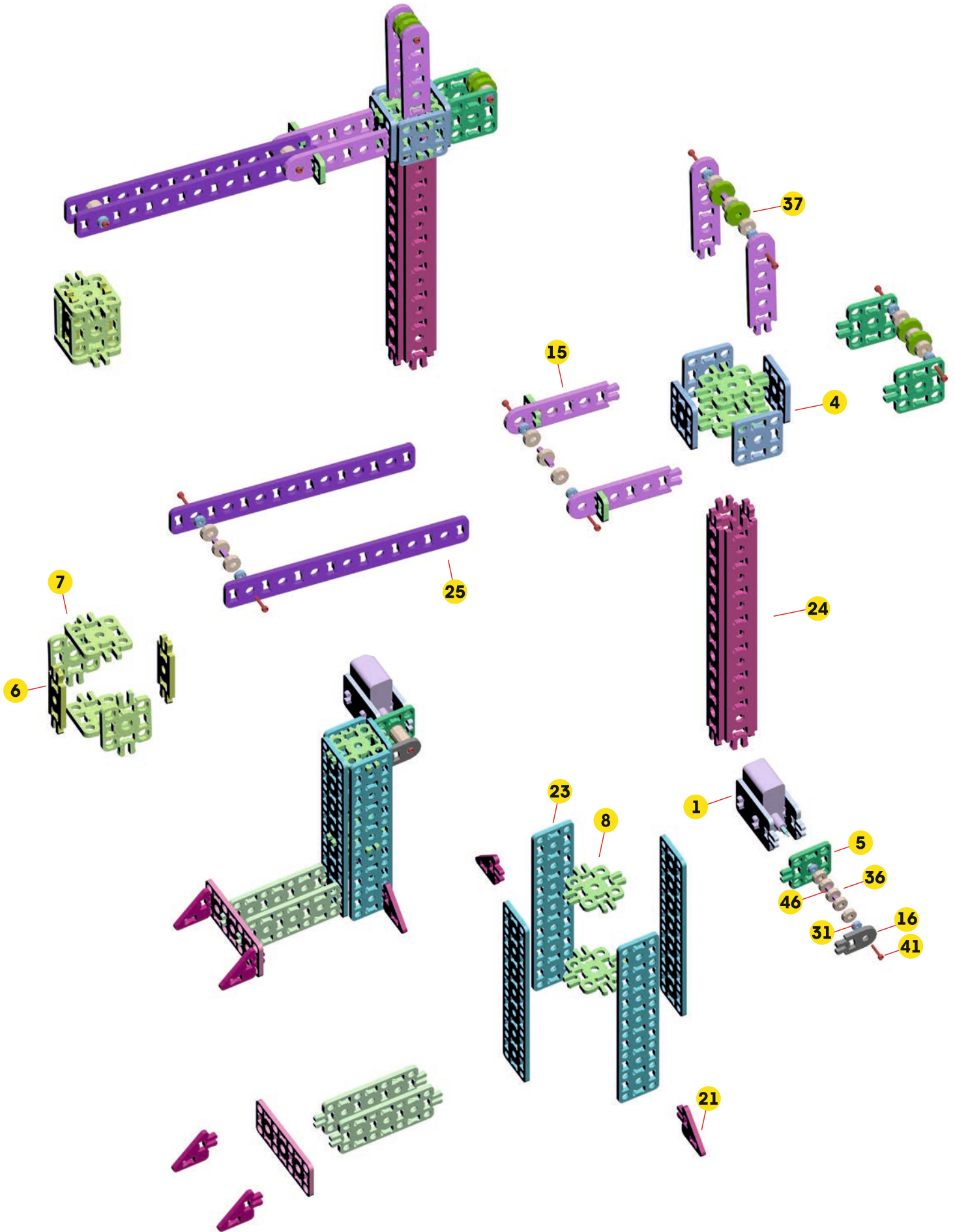

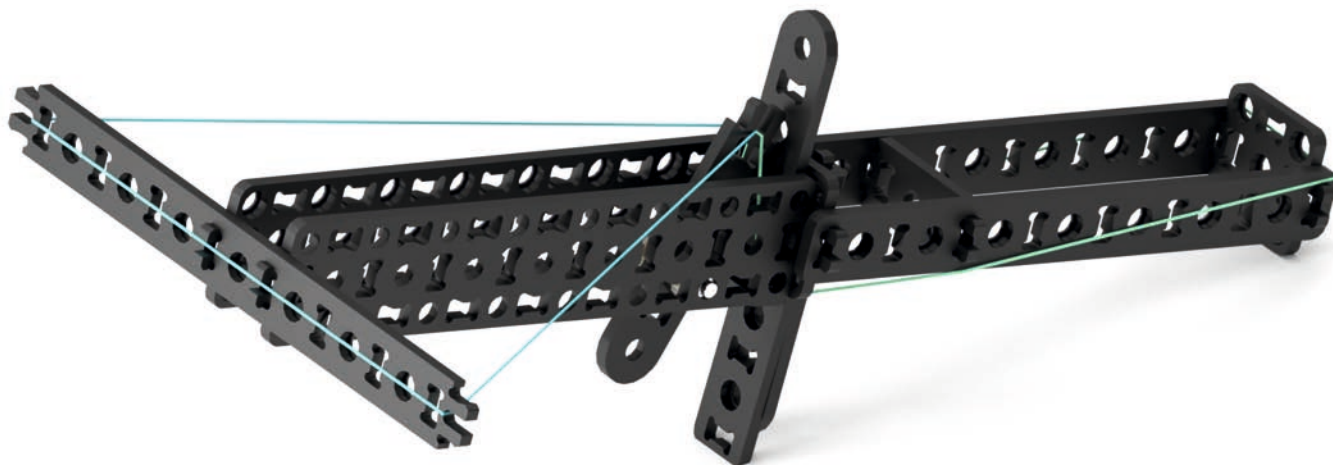

ИСПОЛЬЗУЕМЫЕ ДЕТАЛИ ДЛЯ СБОРКИ

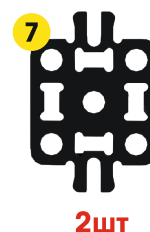

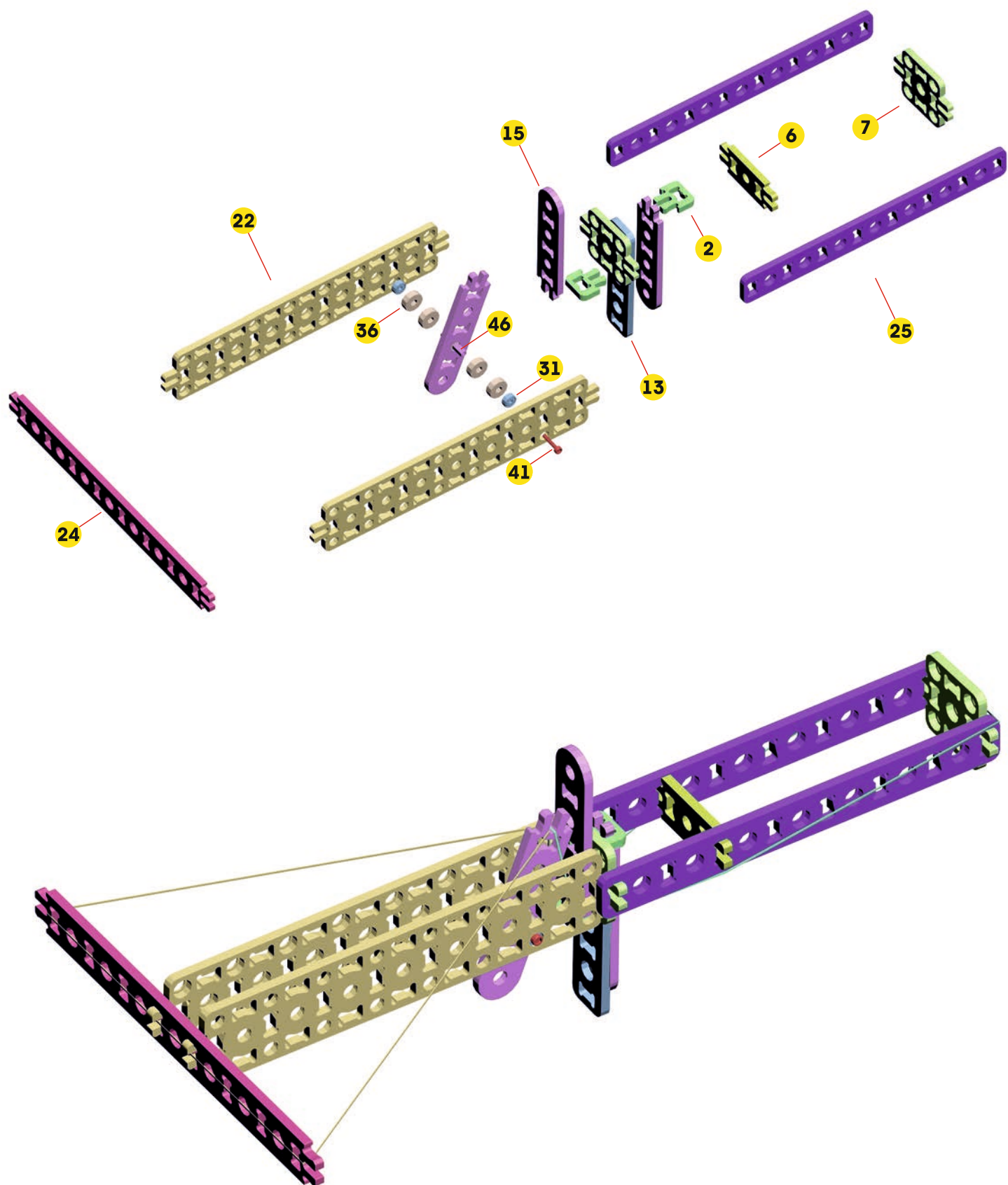



ИСПОЛЬЗУЕМЫЕ ДЕТАЛИ ДЛЯ СБОРКИ



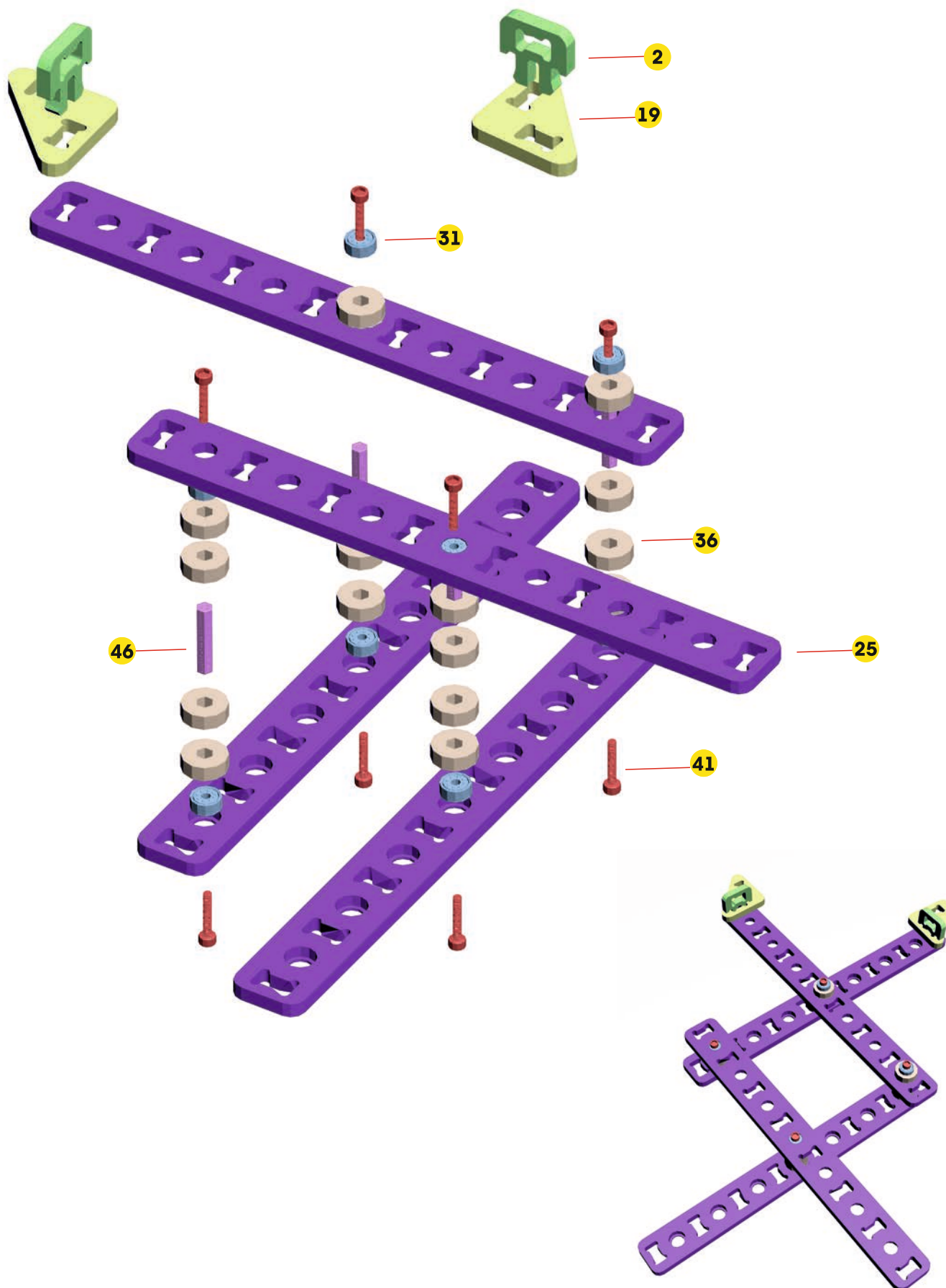

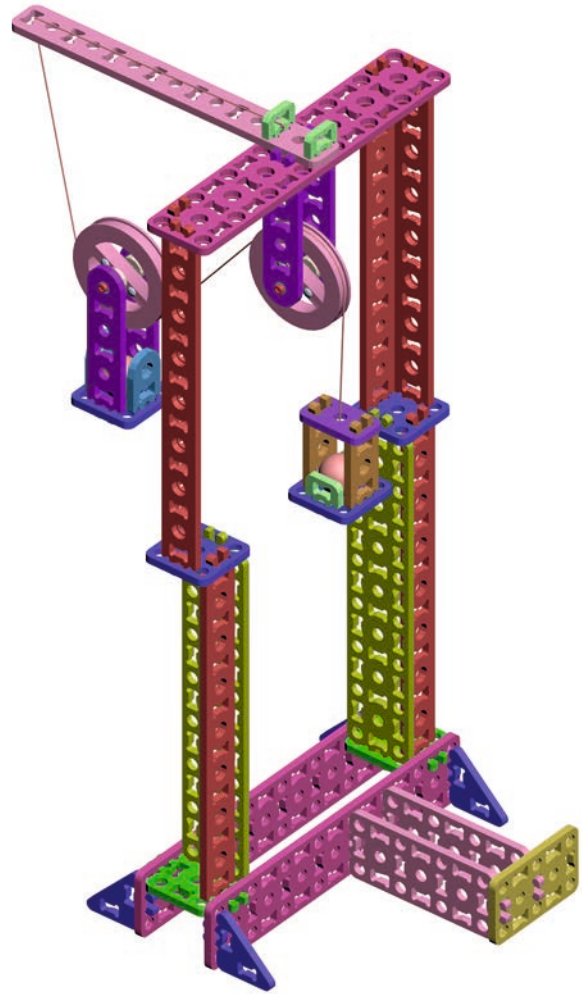

ИСПОЛЬЗУЕМЫЕ ДЕТАЛИ ДЛЯ СБОРКИ

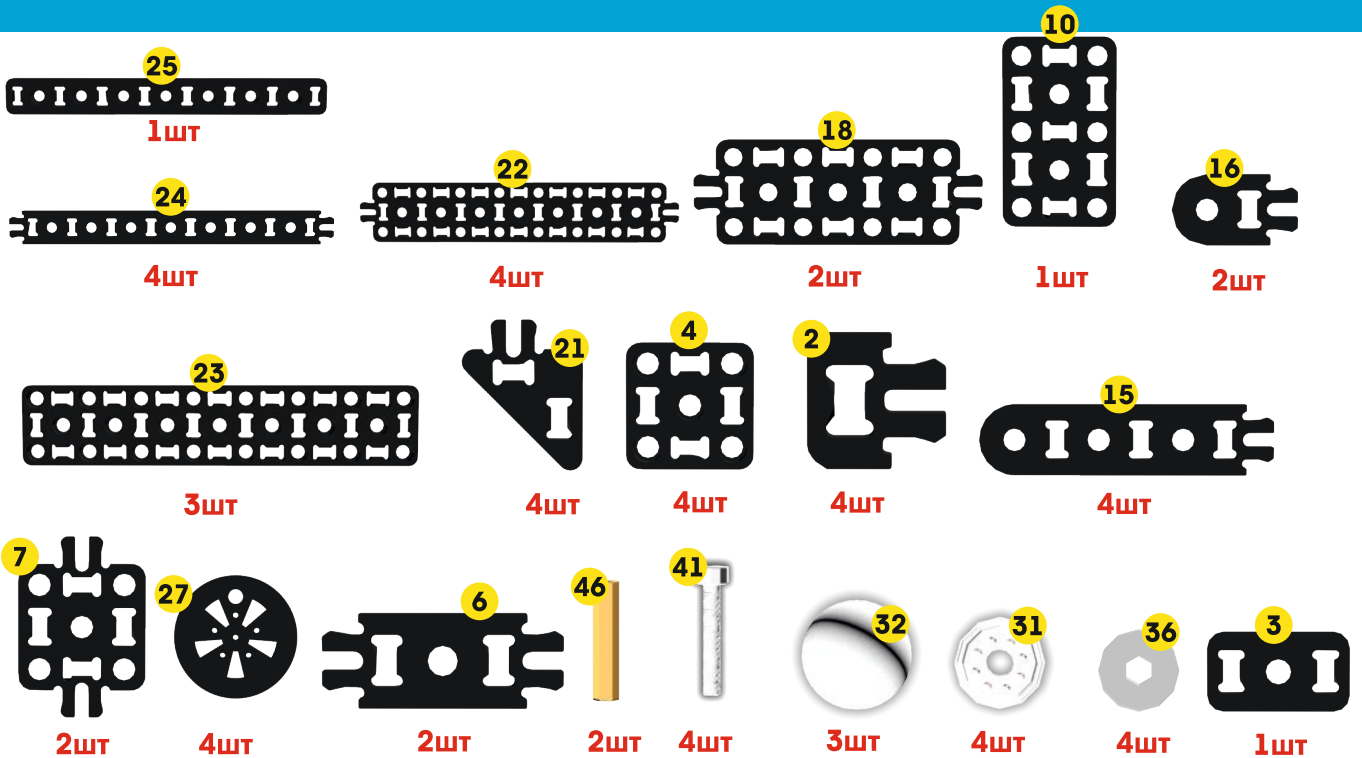

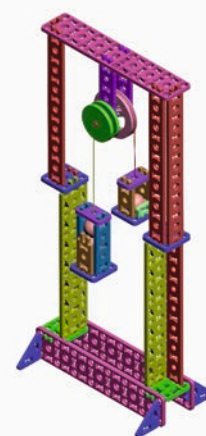
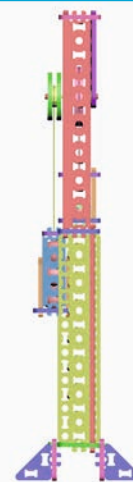
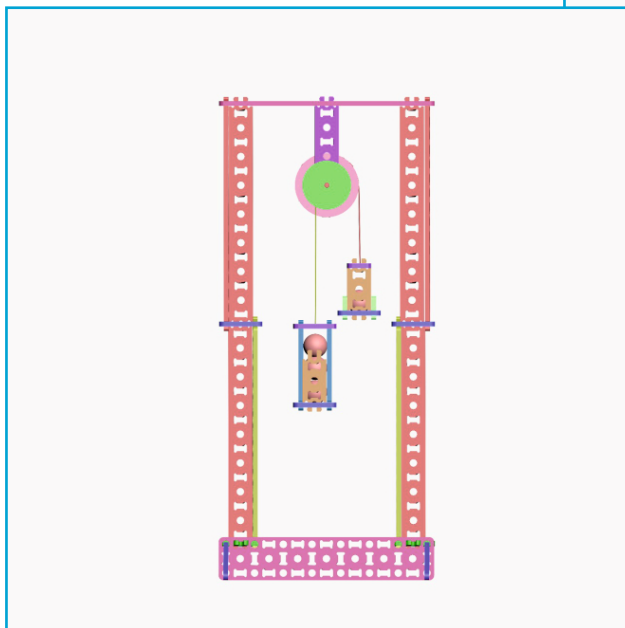

ИСПОЛЬЗУЕМЫЕ ДЕТАЛИ ДЛЯ СБОРКИ

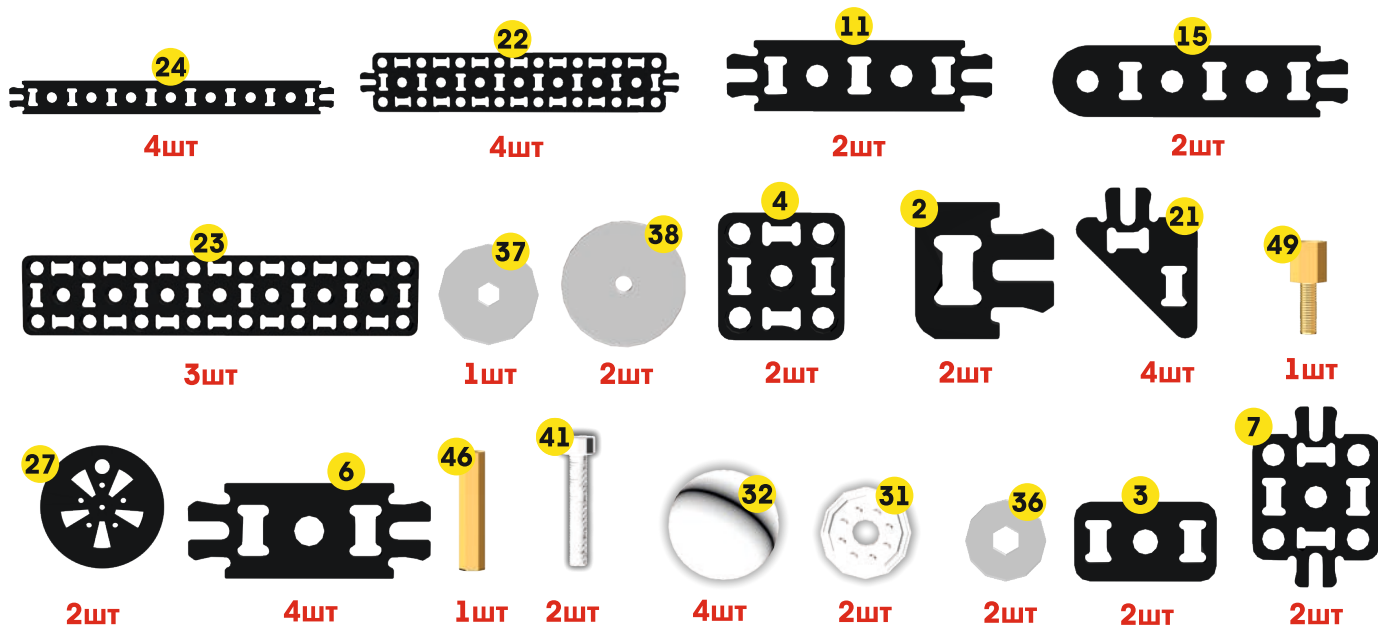

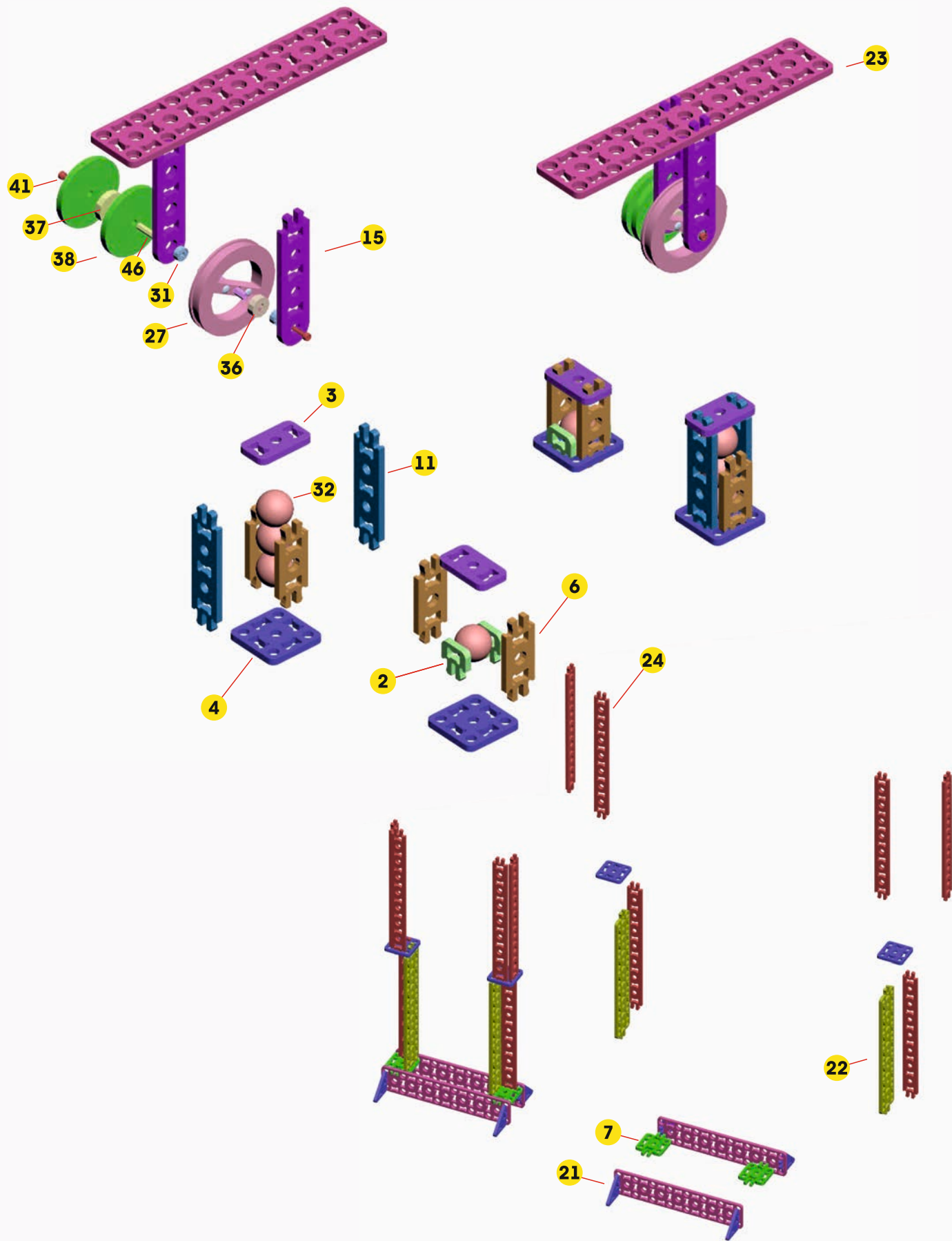

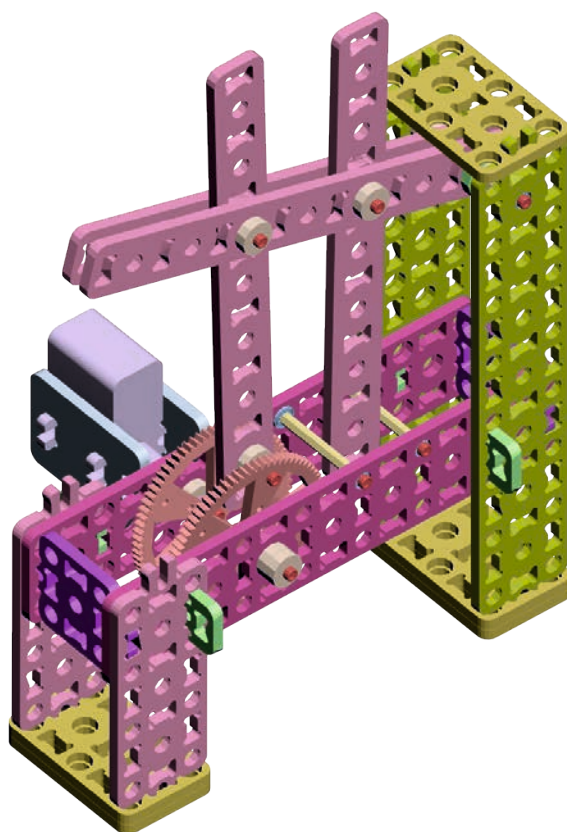
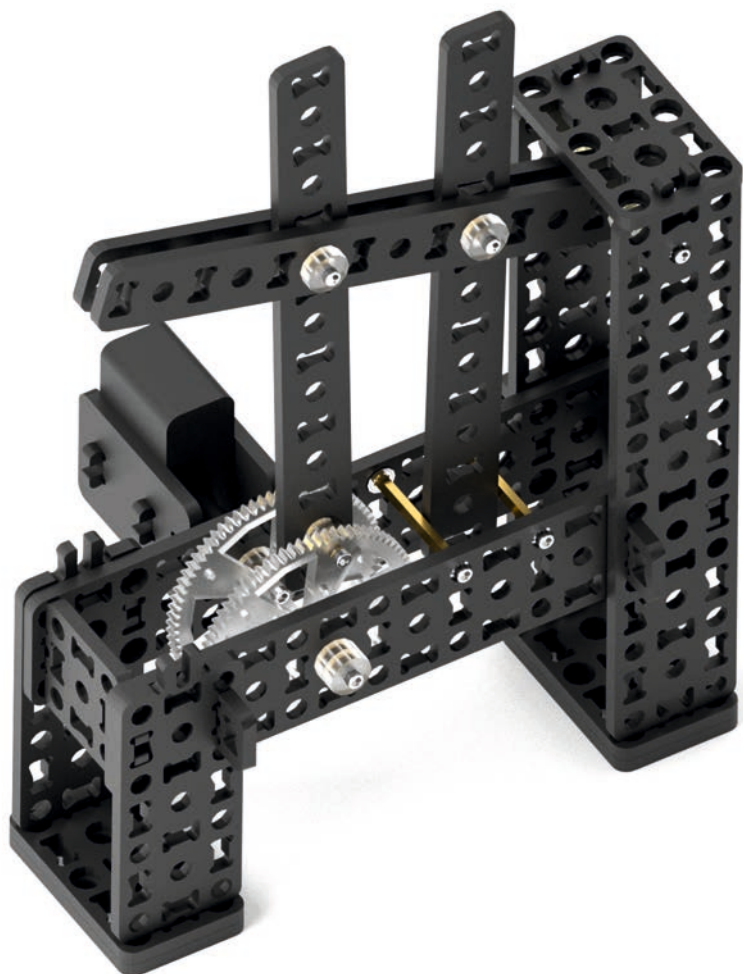

ИСПОЛЬЗУЕМЫЕ ДЕТАЛИ ДЛЯ СБОРКИ

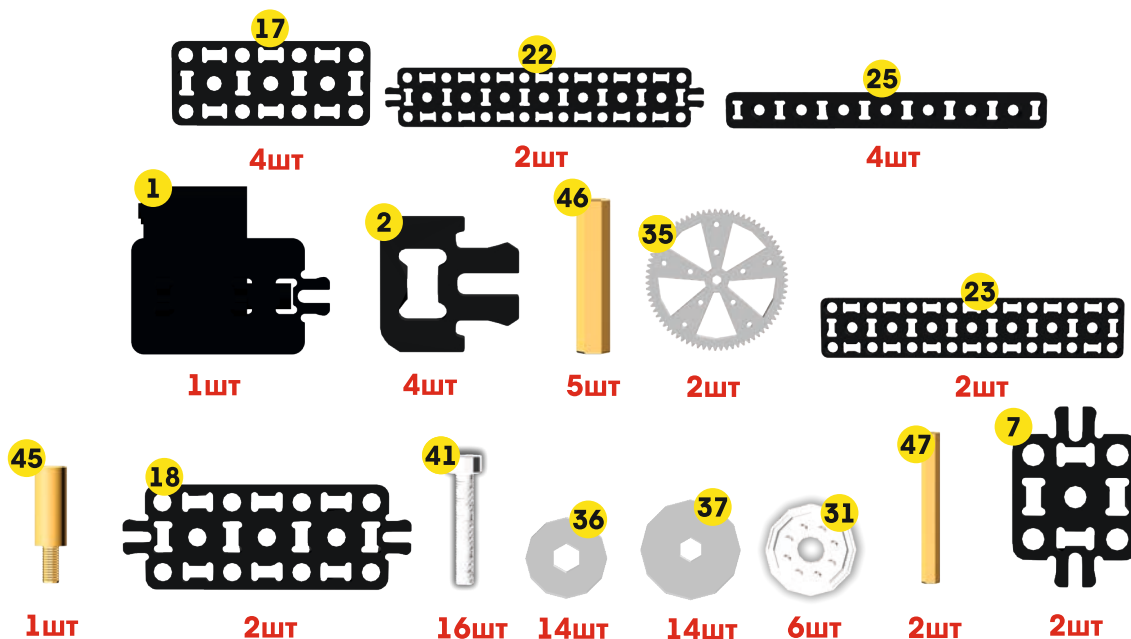

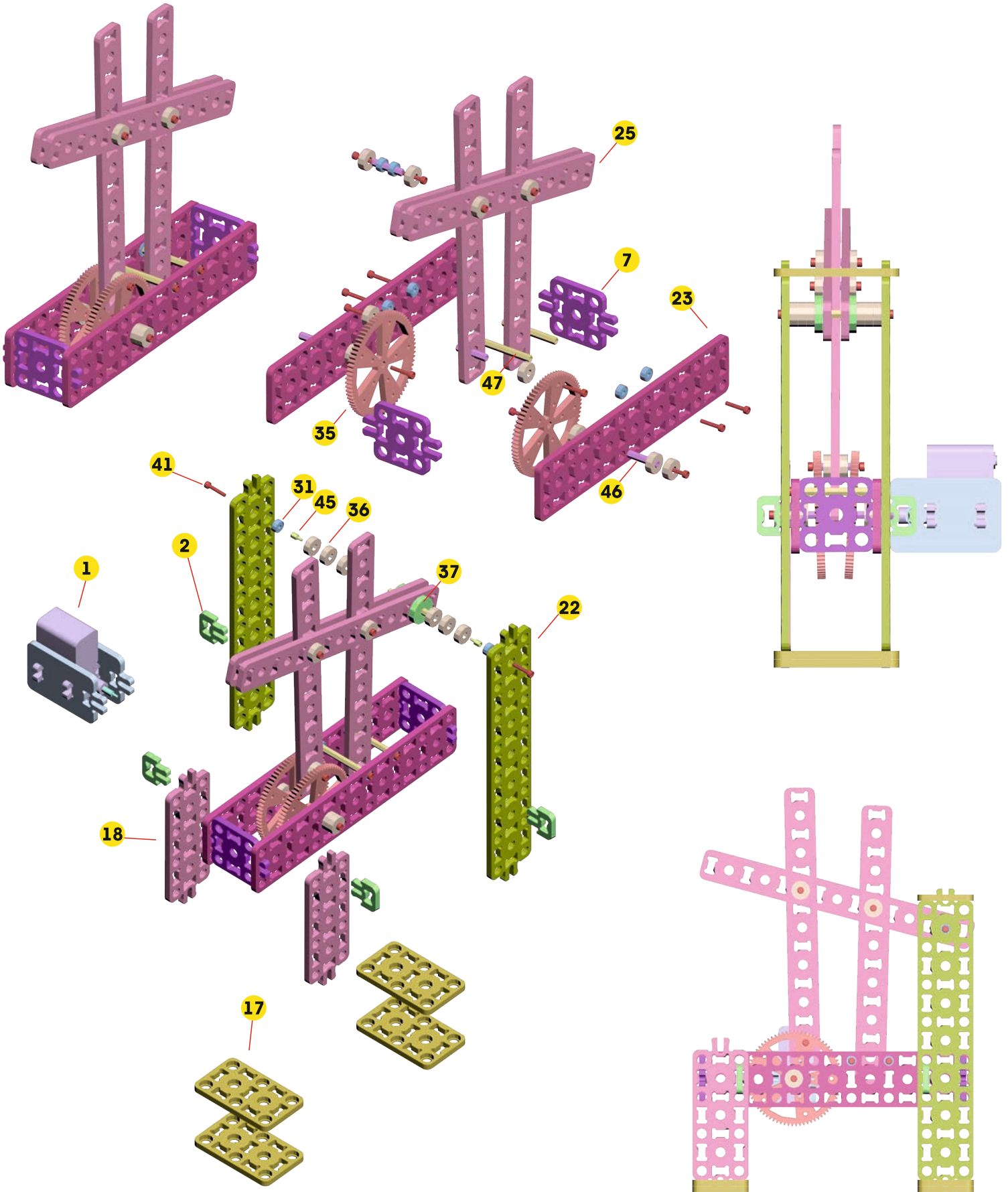

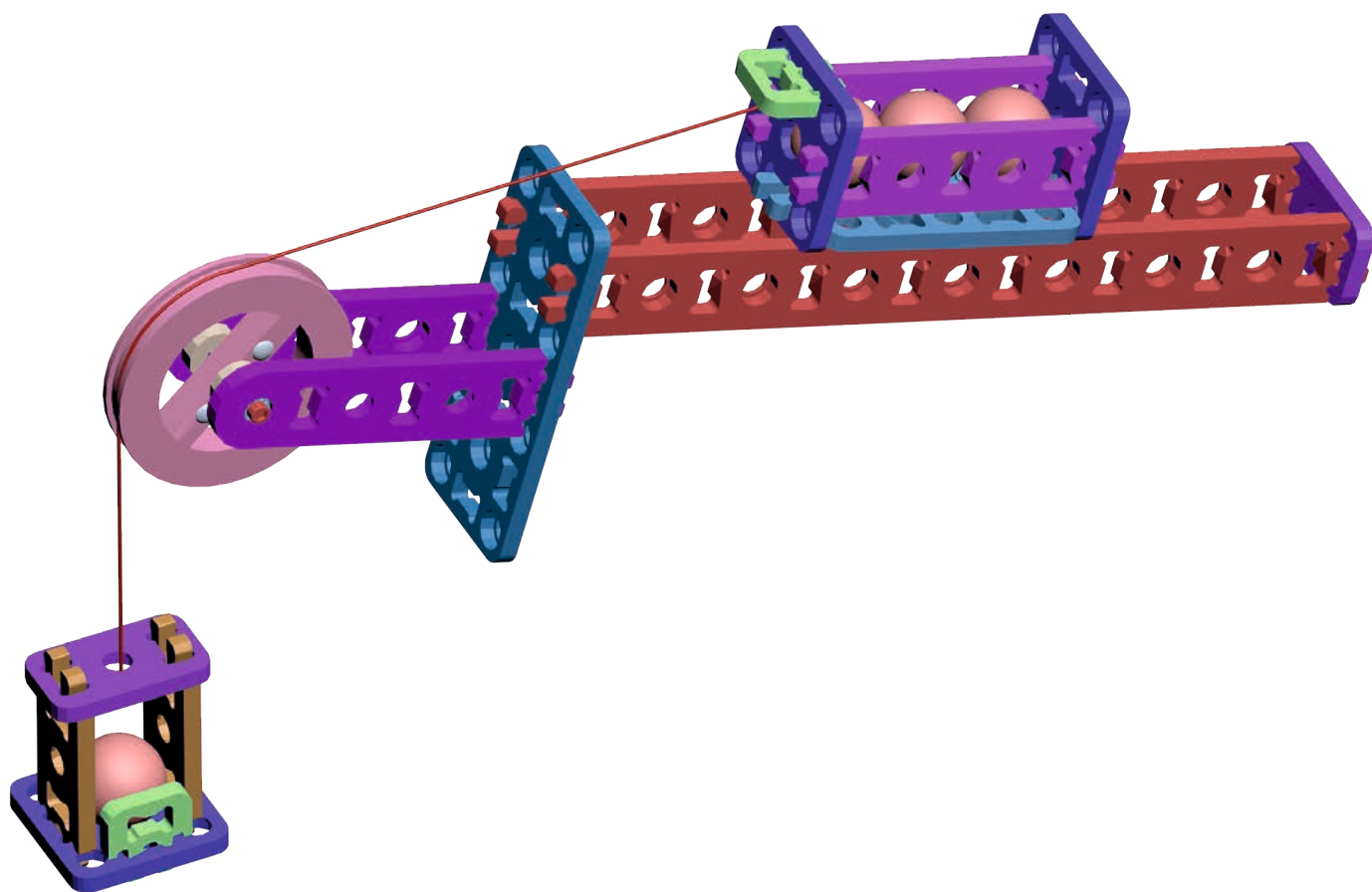

ИСПОЛЬЗУЕМЫЕ ДЕТАЛИ ДЛЯ СБОРКИ

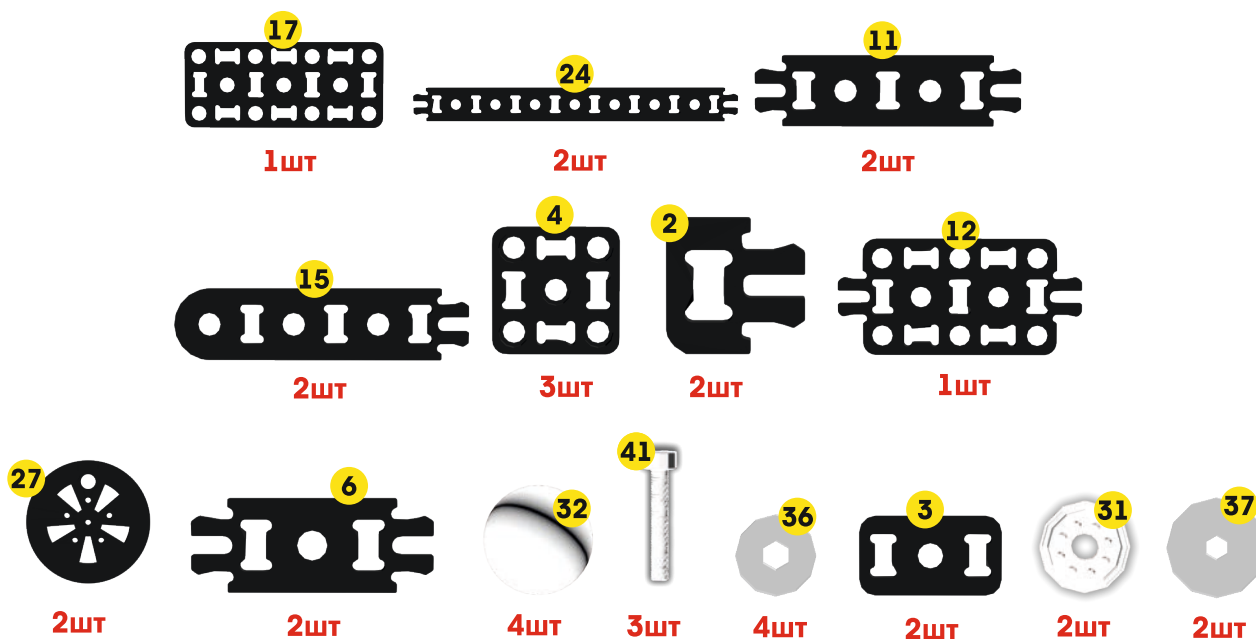

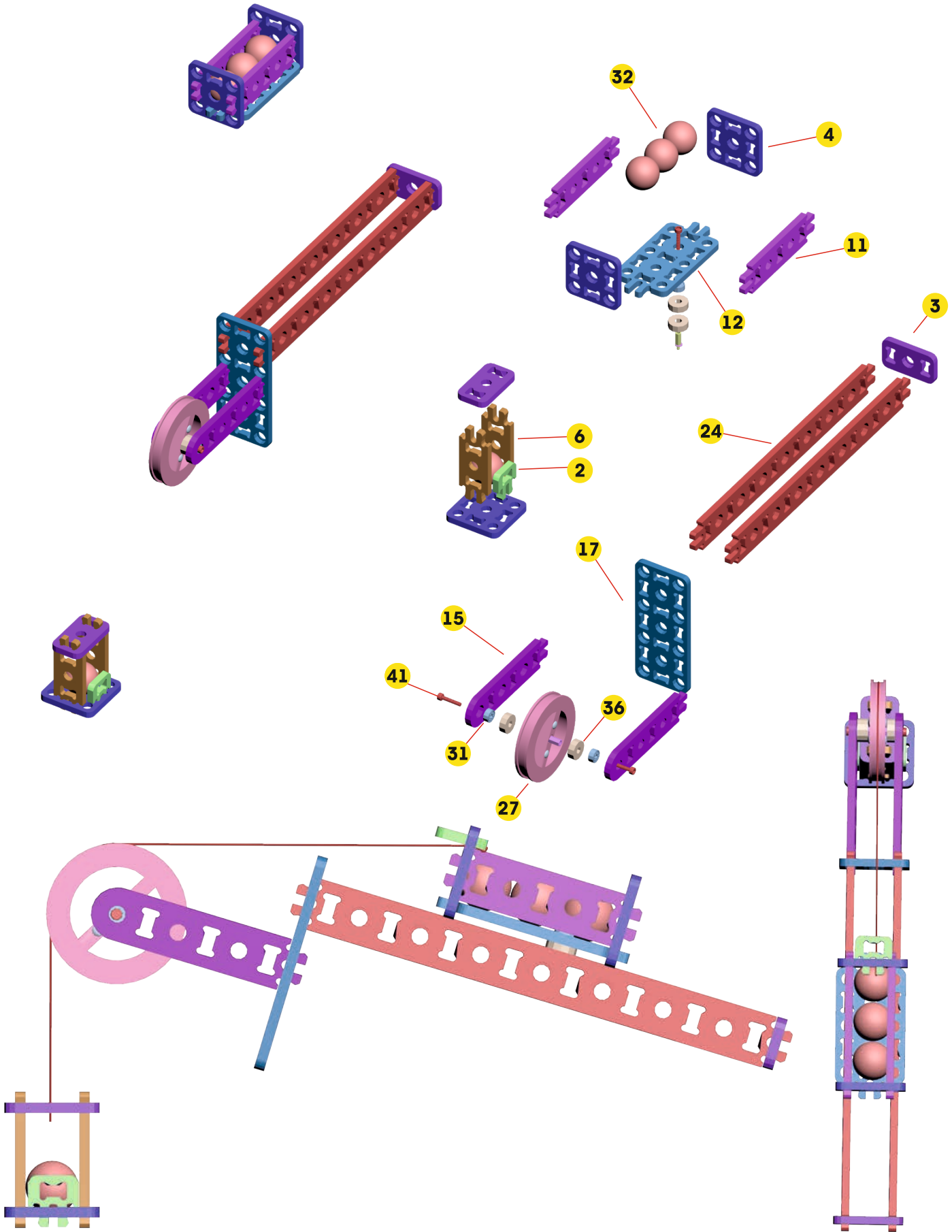

ИСПОЛЬЗУЕМЫЕ ДЕТАЛИ ДЛЯ СБОРКИ

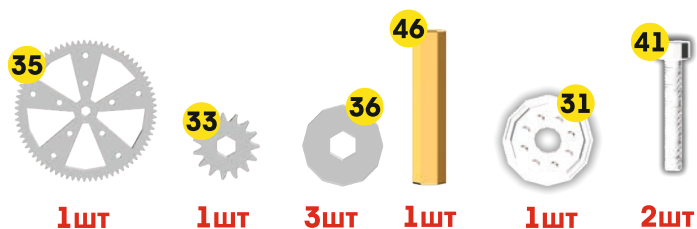

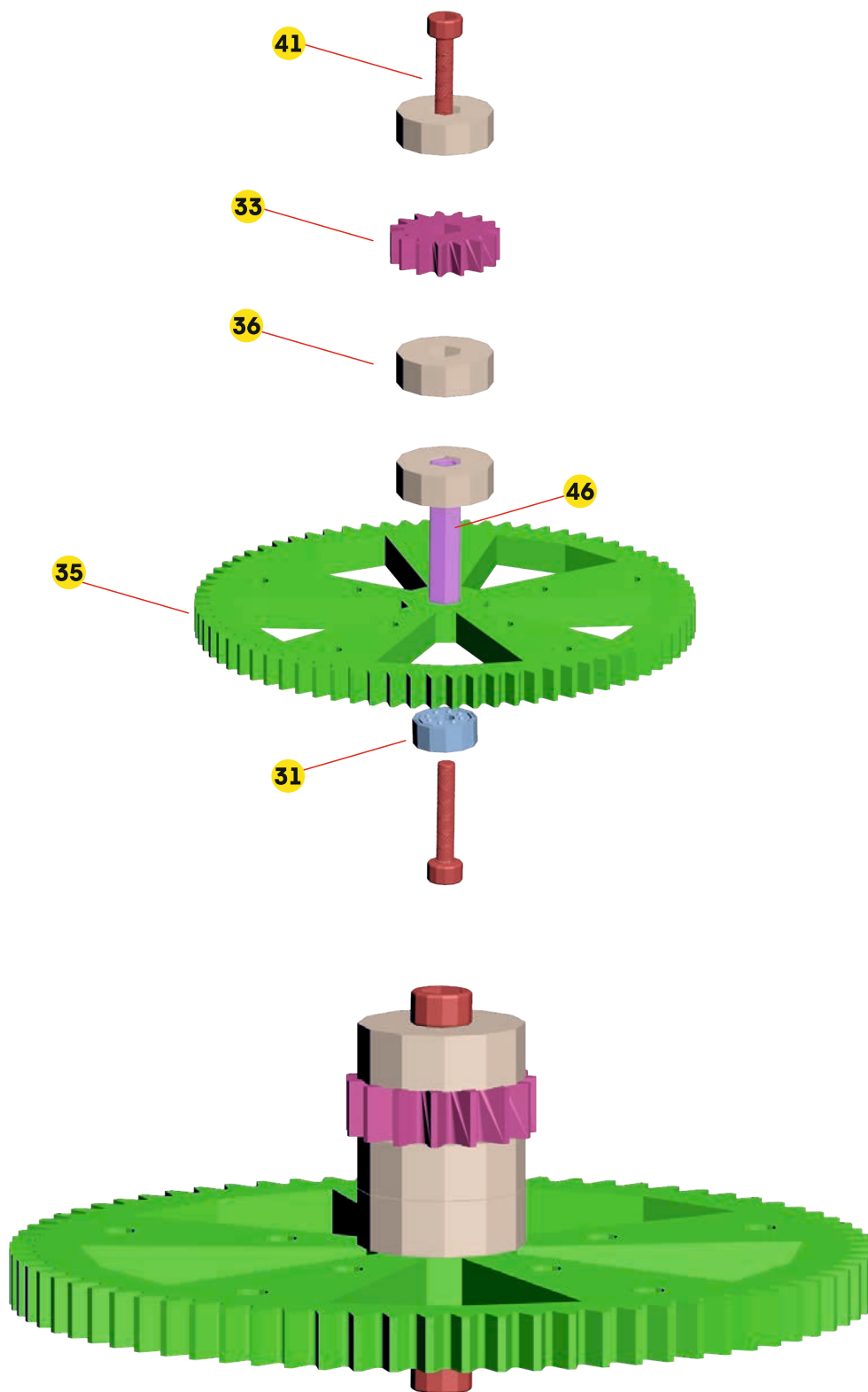

ИСПОЛЬЗУЕМЫЕ ДЕТАЛИ ДЛЯ СБОРКИ

